

DIGITAL CLOCK DISTRIBUTOR

521 CE MARK COMPLIANT

TEST AND ACCEPTANCE

CONTENTS	PAGE	Figures (Contd)	Page
1. GENERAL	2	12. TNC-E/C Card Switch	50
2. ACCEPTANCE TEST PROCEDURES	3	13. TNC/C Card Switch	55
Charts		14. LNC/C Card Switch.....	56
1. 090-44018-05 MIS/C Card Test	8	15. EA10/C and EA10M/C Card Switches ..	63
2. 090-44018-15 MIS/C Card Test	15	16. EA10/C, EA10M/C, TOEA/C, TO-EA/C, and TO-EA5/C Card Digital Output Waveform	65
3. 090-44018-14 MIS/C Card Test	21	17. EA10/C, EA10M/C, TO-EA/C, TO-EA5/C, and TOGA/C Card Analog Output Waveform	66
4. SAI/C Card Test	26	18. TOAA/C Card Switch	68
5. MRC/C Card Test	29	19. TOLA/C Card Switch	69
6. ACI/C Card Test	34	20. TOAA/C Card Output Waveform	72
7. CI-EA/C Card Test	37	21. TOLA/C Card Output Waveform	72
8. CI/C Card Test	40	22. TOCA/C Card Switch	74
9. DCIM-EA/C Card Test	43	23. TOEA/C Card Switch	75
10. TNC-E/C Card Test	46	24. TOTA/C Card Switch	76
11. TNC/C and LNC/C Card Test	51	25. TOCA/C Card Output Waveform	77
12. TNC-E/C Card with TNC/C or LNC/C Card Test	57	26. TOTA/C Card Output Waveform	77
13. EA10/C and EA10M/C Card Test	61	27. TO-EA/C Card Switch	80
14. TOAA/C and TOLA/C Card Test	67	28. TO-EA5/C Card Switch	84
15. TOCA/C, TOEA/C, and TOTA/C Card Test	73	29. TOGA/C Card Switch	88
16. TO-EA/C Card Test	78	30. ESCIU/C Card Switches	94
17. TO-EA5/C Card Test	82	31. PSM/C Card Switches	98
18. TOGA/C Output Card Test	86	Tables	
19. ESCIU/C Card Test	89	A. Master Shelf Test Flow	3
20. PSM/C Card Test	97	B. Expansion Shelf Test Flow	4
21. MIS/C Card System Management Setup	102	C. Typical Oscilloscope Settings	5
Figures		D. MRC-EA/C Card Switch SW1 Settings ..	33
1. Card Positions in Master Shelf	6	E. MRC-T /C Card Switch SW1 Settings	33
2. Card Positions in Expansion Shelf	7	F. MRC/C Card Switch SW3 Settings	33
3. Common Equipment Panel	13	G. EA10/C and EA10M/C Switch Settings ..	64
4. 090-44018-05 MIS/C Card Switch	14	H. TOLA/C Card Output Frequencies (From Wire-wrap Module)	70
5. 090-44018-15 MIS/C Card Switch	20	I. Wire-Wrap Output Connections for TOLA -03/C Only	71
6. 090-44018-14 MIS/C Card Switch	25	J. TO-EA/C Card Switch Settings	81
7. MRC/C Card Switch	32	K. TO-EA5/C Card Switch Settings	85
8. ACI/C Card Switch	36	L. ESCIU/C Card SW1 and SW2 Settings ...	95
9. CI-EA/C Card Switch	39	M. ESCIU/C Card LOS/OOF Switch Settings	96
10. CI/C Card Switch	42		
11. DCIM-EA/C Card Switch.....	45		

Tables (Contd)	Page
N. PSM-T/C and PSM-E/C Card Switch SW1 Settings	99
O. PSM-EA/C Card Switch SW1 Settings	99
P. PSM-E/C and PSM-EA/C Card Switch SW3 Settings	100
Q. PSM-T/C Card Switch SW3 Settings	101
R. Test Sign-off	104

1. GENERAL

1.01 This section provides test and acceptance procedures for the Digital Clock Distributor 521 CE Mark Compliant (DCD-521/C) System.

1.02 This section was reissued for the reasons listed below. Changes and additions are marked by change bars.

- Changed Figures 4, 5, and 6 to show new location of SW1 for Rev. B or later MIS/C card.
- Changed Chart 14 to include information for all TOAA/C cards.
- Changed Figure 18 and Figure 20 to include information for all TOAA/C cards.

1.03 Symmetricom is a registered trademark of Symmetricom, Inc. DCD and Version 5 are trademarks of Symmetricom, Inc. All other product names, service marks, trademarks, and registered trademarks used in this document are the property of their respective owners.

1.04 When acceptance testing has been completed, file the Sign-off sheet locally per local company practice.

1.05 The following abbreviations are used in this section:

DCD	Digital Clock Distributor
E1	European Signal, Level 1 (2.048 Mb/s)
GPS	global positioning system

LNC	Local Node Clock
PRC	Primary Reference Clock
SSU	Synchronization Supply Unit
TNC	Transit Node Clock
TO	timing output card or slot

Notes:

1. Where information is common to the MRC-EA/C, MRC-EA/C^{V5}, CI-EA/C, ACI/C, CI/C, and DCIM-EA/C cards, these cards are collectively referred to as clock input cards.
2. Where information is common to the MRC-EA/C, MRC-EA/C^{V5}, MRC-T/C, and MRC-T/C^{V5} cards, these cards are collectively referred to as MRC/C cards.
3. Where information is common to the PSM-E/C, PSM-EA/C, and PSM-T/C cards, these cards are collectively referred to as PSM/C cards.
4. Where information is common to the TNC-E/C, TNC/C, and LNC/C cards, these cards are collectively referred to as clock cards.
5. Where information is common to the EA10/C and EA10M/C cards, these cards are collectively referred to as EA/C cards.
6. Reference to wire gauge size is listed in wire diameter in mils and mm with the American Wire Gauge (AWG) designation in parenthesis.

1.06 The DCD-521/C System consists of a single shelf that can serve as either a master or an expansion shelf. For this reason, the term “expansion shelf” in this document will refer to the DCD-521/C Shelf used in an expansion shelf capacity, and the term “master shelf” refers to the DCD-521/C Shelf used in a master shelf capacity.

1.07 The DCD-521/C conforms to the European Standards EN55022, EN50082-1, and EN60950, and carries the CE Mark certification.

2. ACCEPTANCE TEST PROCEDURES

2.01 When performing any of the acceptance test procedures, if problems are encountered, or if requirements listed in a step are not met, contact your local Symmetricom distributor, or call Symmetricom’s Customer Technical Assistance Center (CTAC) at one of the following:

- +44 1483 510300 (U.K.)
- +1 408 428 7907 (U.S.A.)

Note: The following toll-free number is available in some countries to access the CTAC office in the U.S.A.:

- +1 888 367 7966 (U.S.A.)

2.02 Acceptance testing should be performed after installing and connecting the master and expansion shelves, applying power to each shelf, and connecting reference inputs to the master shelf. The cabling from the office alarm system, E2A telemetry equipment and timing outputs must not be terminated on the shelves prior to acceptance testing. After acceptance testing has been completed, return to the Installation section of this manual to make these connections.

2.03 The procedures listed in this section assume that this is an initial installation of a DCD-521/C System. For procedures for an existing system, refer to the Maintenance section of this manual.

2.04 To test the DCD-521/C, perform the tests listed in Table A for the master shelf. Then perform the tests listed in Table B for each expansion shelf. If the shelf is not equipped with a particular card, skip that chart.

Table A. Master Shelf Test Flow

CHART	TITLE
1	090-44018-05 MIS/C Card Test
2	090-44018-15 MIS/C Card Test
3	090-44018-14 MIS/C Card Test
4	SAI/C Card Test
5	MRC/C Card Test
6	ACI/C Card Test
7	CI-EA/C Card Test
8	CI/C Card Test
9	DCIM-EA/C Card Test
10	TNC-E/C Card Test
11	TNC/C and LNC/C Card Test
12	TNC-E/C Card with TNC/C or LNC/C Card Test
13	EA10/C and EA10M/C Card Test
14	TOAA/C and TOLA/C Card Test
15	TOCA/C, TOEA/C, and TOTA/C Card Test
16	TO-EA/C Card Test
17	TO-EA5/C Card Test
18	TOGA/C Card Test
19	ESCIU/C Card Test
20	PSM/C Card Test
21	MIS/C Card System Management Setup
<p>Note: Perform the tests on the master shelf in the order shown. If not equipped with a particular card type, skip to the next chart.</p>	

Table B. Expansion Shelf Test Flow

CHART	TITLE
1	090-44018-05 MIS/C Card Test
2	090-44018-15 MIS/C Card Test
3	090-44018-14 MIS/C Card Test
4	SAI/C Card Test
13	EA10/C and EA10M/C Card Test
14	TOAA/C and TOLA/C Card Test
15	TOCA/C, TOEA/C, and TOTA/C Card Test
16	TO-EA/C Card Test
17	TO-EA5/C Card Test
18	TOGA/C Card Test
19	ESCIU/C Card Test
20	PSM/C Card Test
21	MIS/C Card System Management Setup
<p>Note: Perform the tests on each expansion shelf in the order shown. If not equipped with a particular card type, skip to the next chart.</p>	

Card Tests

Warning: When handling cards, use local office procedures regarding electrostatic discharge (ESD), including the following:

- Use grounded wrist straps connected to equipment frame ground when handling cards.
- Store cards only in antistatic packaging provided by the factory.

2.05 System circuit cards are keyed, making it virtually impossible to fully insert a card into the wrong slot. If a card does not seat fully, make sure the card is sliding into the proper slot. Labels printed along the top lip of the shelves identify each slot.

Note: When testing cards, it may be advantageous to have a 50-pin, male-to-male telco connector gender changer readily available for testing the leads on the ALARM/STATUS and ALARM 50-pin connectors.

Note: If a slot is unoccupied, it must be covered with a blank panel or card to ensure the system is CE Mark compliant.

2.06 Use the oscilloscope settings in Table C to verify the amplitude of the inputs before installation, if desired.

Table C. Typical Oscilloscope Settings

CONTROL	SETTING
Mode Trigger Switch	ADD
Invert Switch	INVERT
Ch1 and Ch2: Volts/Div Input Coupling Vert Position Control	See Note AC mid-range
"A" Sweep Mode	AUTO-TRIGGER
Horizontal Display Switch	"A"
Time/Div Switch: for CC for 1.544 Mb/s for Analog (60 kHz) for E1 (2.048 Mb/s) for G.703 (2.048 Mb/s) for Logic Level (TOLA/C)	20 μ s 500 ns 10 μ s 0.1 μ s 0.1 μ s 4 kb/s: 0.5 ms 8 kb/s: 0.1 ms 64 kb/s: 10 μ s 564 kb/s: 2 μ s 384 kb/s: 2 μ s 512 kb/s: 2 μ s 768 kb/s: 2 μ s 1.536 Mb/s: 0.5 μ s 1.5446 Mb/s: 0.5 μ s 2.048 Mb/s: 0.1 μ s
"A" Sweep	FULL
Horizontal Position Control	mid-range
"A" Triggering: Slope Coupling Source	+ or - AC INT
<p>Notes:</p> <ol style="list-style-type: none"> 1. Consult the oscilloscope manufacturer's manual for details and operating instructions. 2. Adjust the oscilloscope's volts-per-division scale to the appropriate level to get a measurable pulse amplitude on the screen; for example, to measure a 0 dB (TERM) signal, set the volts-per-division scale to 1 volt per division; to measure a -20 dB (BRDG) signal, set the volts-per-division scale to 100 mV per division. 	

2.07 Use the following instructions whenever installing a card into a slot:

1. Hold the card by the handles on the faceplate, and carefully align card in the appropriate slot.
2. Secure the card into place by tightening the two screws on the faceplate.

2.08 If a TimeScan product is used in the Test and Acceptance process, whenever a procedure refers to the User's Guide or Operations section, use the appropriate action in the TimeScan product.

2.09 If the alarm and timing outputs have been connected, they must be disconnected to check the outputs of the timing output cards.

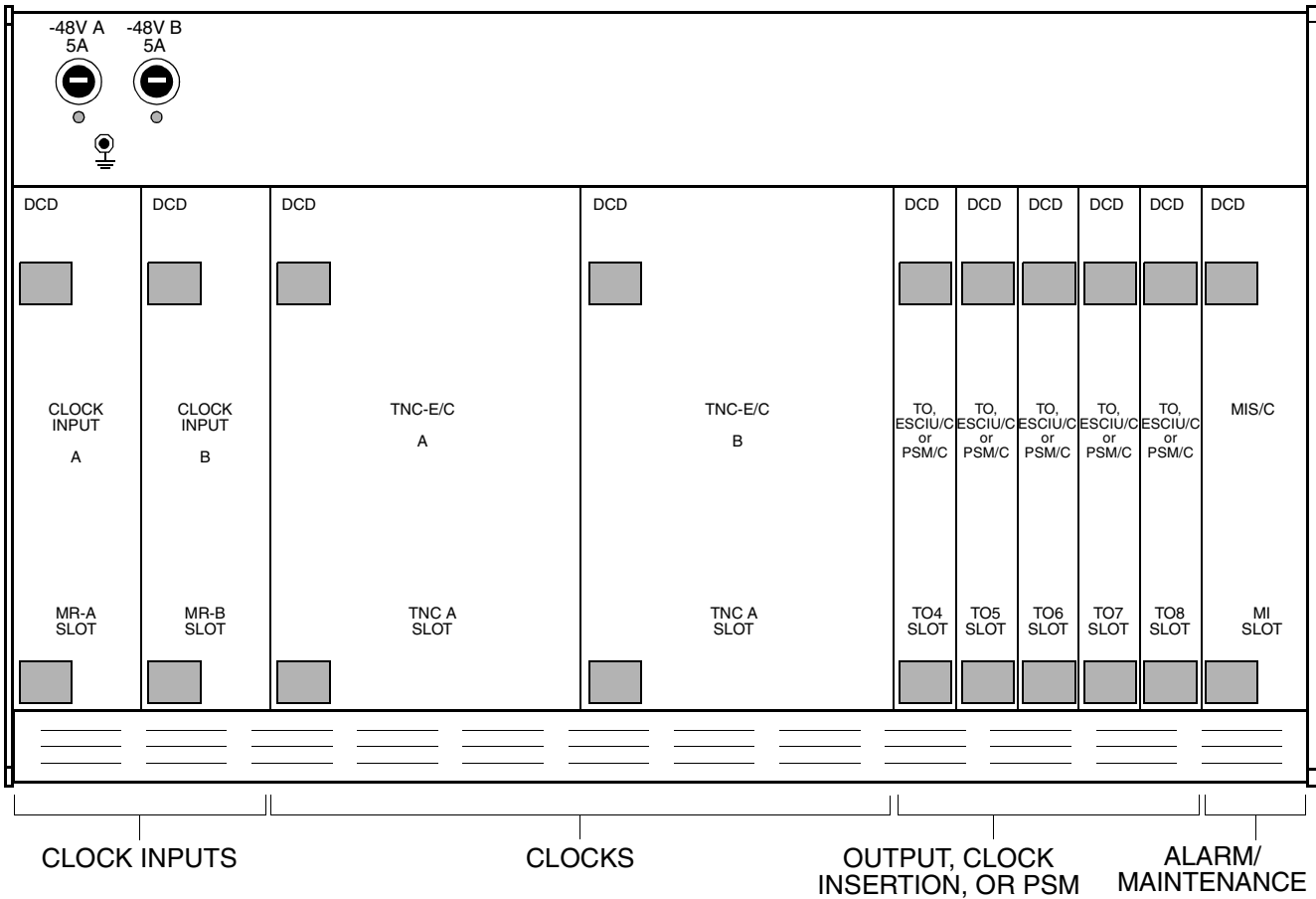

Notes:

1. Redundant output card pairs, if used, must be installed in slot pairs TO1/TO2, TO3/TO4, TO5/TO6, and TO7/TO8. Install a double-wide output module across the appropriate two connectors on the modular mounting panel.
2. The PSM card cannot be installed in slot TO3/TO4.
3. Timing output card pairs, ESCIU/C cards, and PSM/C cards may be intermixed in the shelf; the ESCIU/C and PSM/C cards are unprotected. Stand-alone timing output cards may be installed, but will be unprotected; if stand-alone timing output cards are installed, install a single-wide output module on the appropriate connector on the modular mounting panel.
4. If rubidium clock cards are installed (as shown), timing output slots TO1 through TO3 are occupied by the rubidium clock card in the TNC B slot, and an output card in slot TO4 can only be configured as a stand-alone card.

Figure 1. Card Positions in Master Shelf

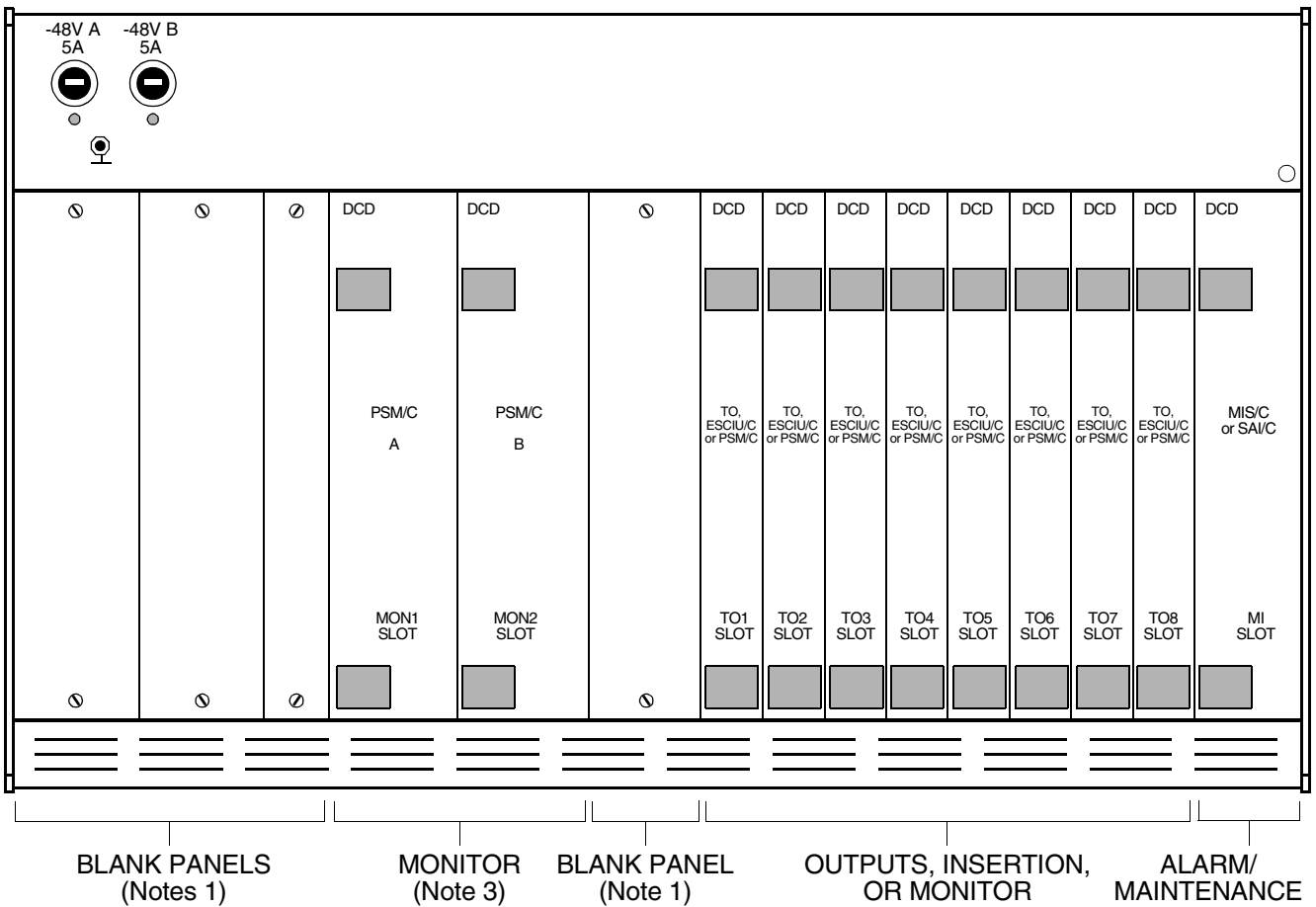

Notes:

1. Timing for the expansion shelf is provided by the master shelf via a cable so clock cards and clock input cards are not required. Any empty slots must be covered by blank panels or blank cards to ensure the system is CE Mark compliant.
2. Redundant output card pairs, if used, must be installed in slots TO1/TO2, TO3/TO4, TO5/TO6, and TO7/TO8. Install a double-wide output module across the appropriate two connectors on the modular mounting panel.
3. Timing output card pairs, ESCIU/C cards, and PSM/C cards may be intermixed in the shelf; the ESCIU/C and PSM/C cards are unprotected. Stand-alone timing output cards may be installed, but will be unprotected; if stand-alone timing output cards are installed, install a single-wide output module on the appropriate connector on the modular mounting panel.

Figure 2. Card Positions in Expansion Shelf

Chart 1. 090-44018-05 MIS/C Card Test

STEP	PROCEDURE
	<p>Use this procedure to install a 090-44018-05 MIS/C card (MIS/C^{V5} card). After all of the cards in the shelf are installed, another procedure populates the MIS/C card's database and allows the card to be the network management node for the DCD Shelf.</p> <p>Notes:</p> <ol style="list-style-type: none"> 1. See the TL1 User's Guide for instructions about commands indicated in this procedure. 2. The MIS/C card allows communication with all three COM ports on the CEP as follows (all ports are set to 9600 baud at the factory, and function equally well if external equipment is set at even, odd, or no parity, 7 or 8 data bits, and 1 stop bit): <ul style="list-style-type: none"> COM1: Configurable for 1200 or 9600 baud via TL1 command only. COM2: Configurable for 1200 or 9600 baud, and even, odd, or no parity via switch setting only. COM3: Configurable for 1200 or 9600 baud via TL1 command only. 3. If an MIS/C card is removed from the shelf, COM1 and COM3 retain the configuration that was set via TL1 command. 4. If the Office Alarm and Shelf Status terminal sets have been connected to the office alarm system and remote telemetry equipment, the ohmmeter tests cannot be performed because the alarm systems apply -48 V at the alarm leads and ground on the return leads. To adequately test the MIS/C card, perform one of the following: <ol style="list-style-type: none"> a. Disconnect the office alarm system and remote telemetry equipment from the DCD-521/C Shelf to perform the ohmmeter tests, then reconnect the leads. b. Leave the office alarm system and remote telemetry equipment connections intact, and substitute the ohmmeter tests with audible and visual tests for appropriate condition responses from the office alarm system and verification of appropriate condition responses at the centralized alarm surveillance and control center. 5. After the INIT-SYS command is completed in this procedure, ignore any messages that may appear on the terminal until the last chart in this Test and Acceptance process. 6. Since no clock cards or clock input cards are installed, the CRITICAL alarm is active after the MIS/C card is installed. 7. The MINOR alarm lamp flashes while the MIS/C card checks the shelf or downloads the database. Wait for the lamp to stop flashing before continuing. <p>Test Equipment: Digital volt/ohm meter</p>
1	Set switch SW1 on the MIS/C card (see Figure 4) according to the factory settings.
2	If COM1 or COM3 are used, skip this step. Check the MIS/C card RS-232 settings to assure communications with the external terminal or computer (see Figure 4).
3	<p>When the RS-232 communications settings on the MIS/C card are correct, insert the MIS card into the slot labeled "MI" in the DCD-21/C master shelf.</p> <p>Requirement: The MIS/C card performs a lamp test, and the MINOR lamp flashes for up to a minute. The CRITICAL and MINOR lamps stay lit.</p>

Chart 1. 090-44018-05 MIS/C Card Test (Contd)

STEP	PROCEDURE
4	<p>Use the terminal to enter a semicolon and a carriage return.</p> <p>Requirement: The terminal displays a three-line message from the MIS/C as follows:</p> <pre style="margin-left: 40px;">TELECOM <date> <time> M <ctag> DENY ICNV ;</pre> <p>Where <date> and <time> are the date and time in the MIS/C card, <ctag> is a random number, and all uppercase letters are shown as they should appear. (See the appropriate TL1 User's Guide for TL1 language definitions.)</p>
5	<p>Refer to the Software Release Document Release for the appropriate software version to install and activate the software.</p>
6	<p>Use the INIT-SYS command with the appropriate <ph> value (see below and the TL1 User's Guide).</p> <p><ph> 3:</p> <ul style="list-style-type: none"> • Deletes all card information from the database • Retains all security information as previously entered, including the users and passwords • Retains the source ID (SID) as previously entered • Retains all communication parameters as previously entered <p><ph> 9:</p> <ul style="list-style-type: none"> • Deletes all card information from the database • Resets all security information to the factory settings • Resets the source ID (SID) to the factory settings, including only one user named "super" with a password of "sparky" • Resets all communication parameters to factory settings <p>Requirement: The terminal indicates a completed command.</p>
7	<p>Jumper the center and MAJ pins on the PWR ALM jumper block (JP1) on the CEP (see Figure 3).</p>
8	<p>Remove the -48V A fuse from the front panel of the shelf with a flat-blade screwdriver.</p> <p>Requirement: The red lamp under the -48V A fuse on the front panel front panel lights. On the MIS/C card, the MAJOR lamp lights red, the MINOR lamp lights yellow.</p>

Chart 1. 090-44018-05 MIS/C Card Test (Contd)

STEP	PROCEDURE																																																																		
9	<p>Connect the multimeter, set to resistance (for the MIN AUD, MIN VIS, MINSI, MAJ AUD, MAJ VIS, MAJSI, CRT AUD, CRT VIS, and CRTSI tests) or to volts dc (for the BATT ALM test) as appropriate, across the following Office Alarm pins and Shelf Status pins of J5 on the CEP (Figure 3):</p> <table border="1" data-bbox="268 528 1348 891"> <thead> <tr> <th>Type</th> <th>Test Point</th> <th>Pin#</th> <th>Test Point</th> <th>Pin#</th> <th>Result</th> </tr> </thead> <tbody> <tr> <td>Office Alarm</td> <td>MIN AUD NO</td> <td>45</td> <td>MIN AUD C</td> <td>20</td> <td><10 Ω</td> </tr> <tr> <td>Office Alarm</td> <td>MIN VIS NO</td> <td>21</td> <td>MIN VIS C</td> <td>47</td> <td><10 Ω</td> </tr> <tr> <td>Office Alarm</td> <td>MAJ AUD NO</td> <td>42</td> <td>MAJ AUD C</td> <td>13</td> <td><10 Ω</td> </tr> <tr> <td>Office Alarm</td> <td>MAJ VIS NO</td> <td>18</td> <td>MAJ VIS C</td> <td>44</td> <td><10 Ω</td> </tr> <tr> <td>Office Alarm</td> <td>CRT AUD NO</td> <td>39</td> <td>CRT AUD C</td> <td>14</td> <td><10 Ω</td> </tr> <tr> <td>Office Alarm</td> <td>CRT VIS NO</td> <td>15</td> <td>CRT VIS C</td> <td>41</td> <td><10 Ω</td> </tr> <tr> <td>Shelf Status</td> <td>MINSI</td> <td>11</td> <td>MINSR</td> <td>36</td> <td><10 Ω</td> </tr> <tr> <td>Shelf Status</td> <td>MAJSI</td> <td>12</td> <td>MAJSR</td> <td>37</td> <td><10 Ω</td> </tr> <tr> <td>Shelf Status</td> <td>CRTSI</td> <td>10</td> <td>CRTSR</td> <td>35</td> <td><10 Ω</td> </tr> <tr> <td>Shelf Status</td> <td>BATTALM</td> <td>13</td> <td>BATTRTN</td> <td>38</td> <td><0.1 V dc</td> </tr> </tbody> </table> <p>Note: When testing cards, it may be advantageous to have a 50-pin, male-to-male telco connector gender changer readily available for testing the leads on J5 and J6.</p> <p>Requirement: The multimeter indicates the readings shown in the Result column.</p>	Type	Test Point	Pin#	Test Point	Pin#	Result	Office Alarm	MIN AUD NO	45	MIN AUD C	20	<10 Ω	Office Alarm	MIN VIS NO	21	MIN VIS C	47	<10 Ω	Office Alarm	MAJ AUD NO	42	MAJ AUD C	13	<10 Ω	Office Alarm	MAJ VIS NO	18	MAJ VIS C	44	<10 Ω	Office Alarm	CRT AUD NO	39	CRT AUD C	14	<10 Ω	Office Alarm	CRT VIS NO	15	CRT VIS C	41	<10 Ω	Shelf Status	MINSI	11	MINSR	36	<10 Ω	Shelf Status	MAJSI	12	MAJSR	37	<10 Ω	Shelf Status	CRTSI	10	CRTSR	35	<10 Ω	Shelf Status	BATTALM	13	BATTRTN	38	<0.1 V dc
Type	Test Point	Pin#	Test Point	Pin#	Result																																																														
Office Alarm	MIN AUD NO	45	MIN AUD C	20	<10 Ω																																																														
Office Alarm	MIN VIS NO	21	MIN VIS C	47	<10 Ω																																																														
Office Alarm	MAJ AUD NO	42	MAJ AUD C	13	<10 Ω																																																														
Office Alarm	MAJ VIS NO	18	MAJ VIS C	44	<10 Ω																																																														
Office Alarm	CRT AUD NO	39	CRT AUD C	14	<10 Ω																																																														
Office Alarm	CRT VIS NO	15	CRT VIS C	41	<10 Ω																																																														
Shelf Status	MINSI	11	MINSR	36	<10 Ω																																																														
Shelf Status	MAJSI	12	MAJSR	37	<10 Ω																																																														
Shelf Status	CRTSI	10	CRTSR	35	<10 Ω																																																														
Shelf Status	BATTALM	13	BATTRTN	38	<0.1 V dc																																																														
10	<p>Press the ACO pushbutton on the MIS/C card.</p> <p>Requirement: The audible office alarm silences (if connected). On the MIS/C card, the ACO lamp lights green.</p>																																																																		
11	<p>Connect the multimeter, set to resistance (for the MINOR AUD, MINOR VIS, MINSI, MAJOR AUD, MAJOR VIS, and MAJSI tests) or to volts dc (for the BATT ALM test) as appropriate, across the following Office Alarm pins and Shelf Status pins of J5 on the CEP (Figure 3):</p> <table border="1" data-bbox="268 1346 1348 1615"> <thead> <tr> <th>Type</th> <th>Test Point</th> <th>Pin#</th> <th>Test Point</th> <th>Pin#</th> <th>Result</th> </tr> </thead> <tbody> <tr> <td>Office Alarm</td> <td>MIN AUD NO</td> <td>45</td> <td>MIN AUD C</td> <td>20</td> <td>>1 MΩ</td> </tr> <tr> <td>Office Alarm</td> <td>MIN VIS NO</td> <td>21</td> <td>MIN VIS C</td> <td>47</td> <td><10 Ω</td> </tr> <tr> <td>Office Alarm</td> <td>MAJ AUD NO</td> <td>42</td> <td>MAJ AUD C</td> <td>13</td> <td>>1 MΩ</td> </tr> <tr> <td>Office Alarm</td> <td>MAJ VIS NO</td> <td>18</td> <td>MAJ VIS C</td> <td>44</td> <td><10 Ω</td> </tr> <tr> <td>Shelf Status</td> <td>MINSI</td> <td>11</td> <td>MINSR</td> <td>36</td> <td><10 Ω</td> </tr> <tr> <td>Shelf Status</td> <td>MAJSI</td> <td>12</td> <td>MAJSR</td> <td>37</td> <td><10 Ω</td> </tr> <tr> <td>Shelf Status</td> <td>BATTALM</td> <td>13</td> <td>BATTRTN</td> <td>38</td> <td><0.1 V dc</td> </tr> </tbody> </table> <p>Requirement: The multimeter indicates the readings shown in the Result column.</p>	Type	Test Point	Pin#	Test Point	Pin#	Result	Office Alarm	MIN AUD NO	45	MIN AUD C	20	>1 MΩ	Office Alarm	MIN VIS NO	21	MIN VIS C	47	<10 Ω	Office Alarm	MAJ AUD NO	42	MAJ AUD C	13	>1 MΩ	Office Alarm	MAJ VIS NO	18	MAJ VIS C	44	<10 Ω	Shelf Status	MINSI	11	MINSR	36	<10 Ω	Shelf Status	MAJSI	12	MAJSR	37	<10 Ω	Shelf Status	BATTALM	13	BATTRTN	38	<0.1 V dc																		
Type	Test Point	Pin#	Test Point	Pin#	Result																																																														
Office Alarm	MIN AUD NO	45	MIN AUD C	20	>1 MΩ																																																														
Office Alarm	MIN VIS NO	21	MIN VIS C	47	<10 Ω																																																														
Office Alarm	MAJ AUD NO	42	MAJ AUD C	13	>1 MΩ																																																														
Office Alarm	MAJ VIS NO	18	MAJ VIS C	44	<10 Ω																																																														
Shelf Status	MINSI	11	MINSR	36	<10 Ω																																																														
Shelf Status	MAJSI	12	MAJSR	37	<10 Ω																																																														
Shelf Status	BATTALM	13	BATTRTN	38	<0.1 V dc																																																														
12	<p>Replace the -48V A fuse, using a flat-blade screwdriver to lock in place.</p> <p>Requirement: The -48V A fuse lamp goes off. On the MIS/C card, the MAJOR and MINOR lamps go off after up to 12 seconds, and the ACO lamp stays lit (because the CRITICAL alarm is active).</p>																																																																		

Chart 1. 090-44018-05 MIS/C Card Test (Contd)

STEP	PROCEDURE																																																
13	<p>Connect the multimeter, set to resistance (for the MINOR AUD, MINOR VIS, MINSI, MAJOR AUD, MAJOR VIS, and MAJSI tests) or to volts dc (for the BATT ALM test) as appropriate, across the following Office Alarm pins and Shelf Status pins of J5 on the CEP (Figure 3):</p> <table border="1" data-bbox="331 495 1449 763"> <thead> <tr> <th>Type</th> <th>Test Point</th> <th>Pin#</th> <th>Test Point</th> <th>Pin#</th> <th>Result</th> </tr> </thead> <tbody> <tr> <td>Office Alarm</td> <td>MIN AUD NO</td> <td>45</td> <td>MIN AUD C</td> <td>20</td> <td>>1 MΩ</td> </tr> <tr> <td>Office Alarm</td> <td>MIN VIS NO</td> <td>21</td> <td>MIN VIS C</td> <td>47</td> <td>>1 MΩ</td> </tr> <tr> <td>Office Alarm</td> <td>MAJ AUD NO</td> <td>42</td> <td>MAJ AUD C</td> <td>13</td> <td>>1 MΩ</td> </tr> <tr> <td>Office Alarm</td> <td>MAJ VIS NO</td> <td>18</td> <td>MAJ VIS C</td> <td>44</td> <td>>1 MΩ</td> </tr> <tr> <td>Shelf Status</td> <td>MINSI</td> <td>11</td> <td>MINSR</td> <td>36</td> <td>>1 MΩ</td> </tr> <tr> <td>Shelf Status</td> <td>MAJSI</td> <td>12</td> <td>MAJSR</td> <td>37</td> <td>>1 MΩ</td> </tr> <tr> <td>Shelf Status</td> <td>BATTALM</td> <td>13</td> <td>BATTRTN</td> <td>38</td> <td>-42 V dc to -56 V dc</td> </tr> </tbody> </table> <p>Requirement: The multimeter indicates the readings shown in the Result column.</p>	Type	Test Point	Pin#	Test Point	Pin#	Result	Office Alarm	MIN AUD NO	45	MIN AUD C	20	>1 MΩ	Office Alarm	MIN VIS NO	21	MIN VIS C	47	>1 MΩ	Office Alarm	MAJ AUD NO	42	MAJ AUD C	13	>1 MΩ	Office Alarm	MAJ VIS NO	18	MAJ VIS C	44	>1 MΩ	Shelf Status	MINSI	11	MINSR	36	>1 MΩ	Shelf Status	MAJSI	12	MAJSR	37	>1 MΩ	Shelf Status	BATTALM	13	BATTRTN	38	-42 V dc to -56 V dc
Type	Test Point	Pin#	Test Point	Pin#	Result																																												
Office Alarm	MIN AUD NO	45	MIN AUD C	20	>1 MΩ																																												
Office Alarm	MIN VIS NO	21	MIN VIS C	47	>1 MΩ																																												
Office Alarm	MAJ AUD NO	42	MAJ AUD C	13	>1 MΩ																																												
Office Alarm	MAJ VIS NO	18	MAJ VIS C	44	>1 MΩ																																												
Shelf Status	MINSI	11	MINSR	36	>1 MΩ																																												
Shelf Status	MAJSI	12	MAJSR	37	>1 MΩ																																												
Shelf Status	BATTALM	13	BATTRTN	38	-42 V dc to -56 V dc																																												
14	<p>Remove the -48V B fuse from the front panel on the DCD-521/C Shelf, using a flat-blade screwdriver.</p> <p>Requirement: The red lamp under the -48V B fuse on the front panel front panel lights. On the MIS/C card, the MAJOR lamp lights red, the MINOR lamp lights yellow, and the ACO lamp goes off. The the new alarm condition resets the ACO.</p>																																																
15	<p>Press the ACO pushbutton on the MIS/C card.</p> <p>Requirement: The audible office alarm silences (if connected). On the MIS/C card, the ACO lamp lights green.</p>																																																
16	<p>Replace the -48V B fuse, using a flat-blade screwdriver to lock in place.</p> <p>Requirement: The -48V B fuse lamp and the MIS/C MAJOR and MINOR lamps go off (after approximately 6 seconds to 12 seconds), and the ACO lamp stays lit (because the CRITICAL alarm is active).</p>																																																
17	<p>Remove both fuses from the front panel on the DCD-521/C Shelf, using a flat-blade screwdriver.</p> <p>Requirement: All lamps on the MIS/C card and shelf go out. The -48V A and -48V B lamps on the front panel light red.</p>																																																
18	<p>Replace both fuses, using a flat-blade screwdriver to lock in place.</p> <p>Requirement: The CRITICAL, MAJOR, and MINOR lamps on the MIS/C light, then go off, one at a time (the CRITICAL lamp lights to indicate there are no input and clock cards in the shelf). The -48V A and -48V B lamps are off on the front panel. The ACO lamp stays lit (because the CRITICAL alarm is active).</p>																																																
19	<p>Jumper the center and MIN pins on the PWR ALM jumper block (JP1) on the CEP (see Figure 3).</p>																																																
20	<p>Remove fuse “-48V A” from the front panel on the DCD-521/C Shelf with a flat-blade screwdriver.</p> <p>Requirement: The red lamp under the -48V A fuse on the front panel lights, and the MINOR lamp on the MIS/C card lights yellow.</p>																																																

Chart 1. 090-44018-05 MIS/C Card Test (Contd)

STEP	PROCEDURE
21	<p>Press the ACO pushbutton on the MIS/C card.</p> <p>Requirement: The audible office alarm silences (if connected). On the MIS/C card, the ACO lamp lights green.</p>
22	<p>Replace the –48V A fuse, using a flat-blade screwdriver to lock in place.</p> <p>Requirement: –48V A fuse lamp and MIS/C MINOR lamp go off, and the ACO lamp stays lit (because the CRITICAL alarm is active).</p>
23	<p>Remove the –48V B fuse from the front panel on the DCD-521/C Shelf, using a flat-blade screwdriver.</p> <p>Requirement: The red lamp under the –48V B fuse on the front panel front panel lights, and the MINOR lamp on the MIS/C card lights yellow. The ACO lamp on the MIS/C card goes off. The new alarm resets the ACO.</p>
24	<p>Press the ACO pushbutton on the MIS/C card.</p> <p>Requirement: The audible office alarm silences (if connected). On the MIS/C card, the ACO lamp lights green.</p>
25	<p>Replace the –48V B fuse, using a flat-blade screwdriver to lock in place.</p> <p>Requirement: –48V B fuse lamp goes off, MIS/C MINOR lamp goes off, and the ACO lamp stays lit (because the CRITICAL alarm is active).</p>
26	<p>Jumper the pins on the PWR ALM jumper block (JP1) on the CEP (see Figure 3) to conform to the requirements for this installation.</p>
27	<p>Repeat the previous steps in this procedure on each shelf which requires a 090-44018-05 MIS/C card.</p>
28	<p>This procedure is completed. Indicate completion of the 090-44018-05 MIS/C Card Test on the Test Sign-off form.</p>

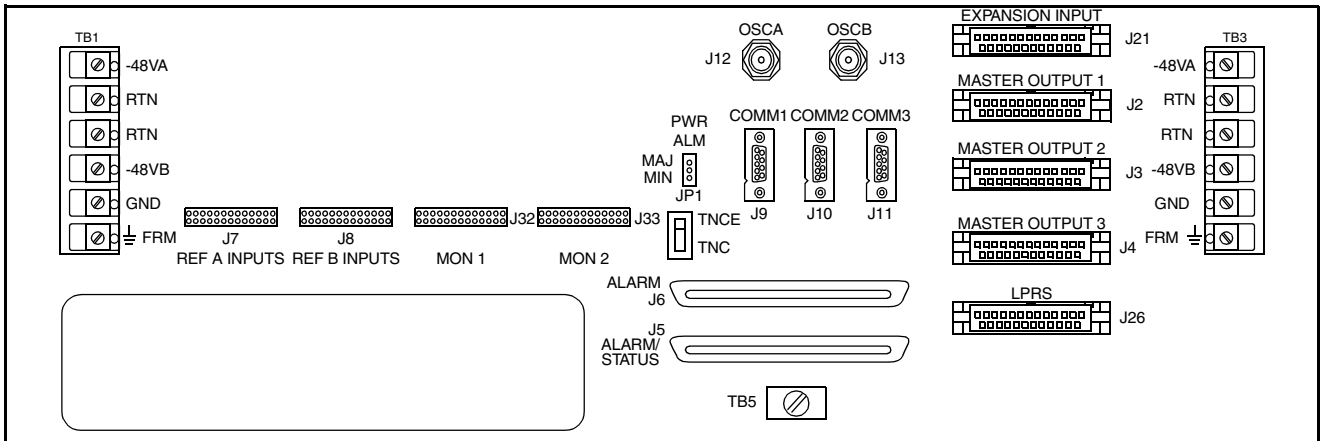
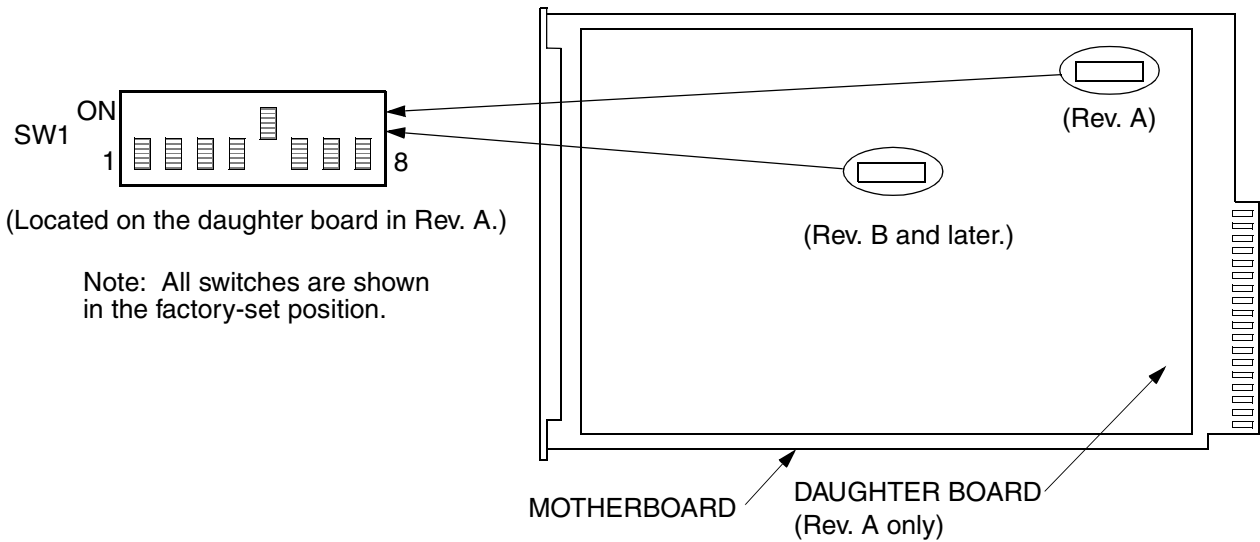

Figure 3. Common Equipment Panel



SW1 Switch Settings

Sw1 Section	Position	Description	Factory Setting
1 (Note 1)	On	1200 Baud	—
	Off	9600 Baud	X
2 and 3 (Note 1)	2=on, 3=any	Odd Parity	—
	2=off, 3=on	Even Parity	—
	2=off, 3=off	No Parity	X
4	On	Password protection enabled	—
	Off	Password protection disabled	X
5	On	When power is applied (or recycled), the MIS/C card downloads its configuration database to the Version 5 cards in the shelf. Only those Version 5 cards in the same slot and with the same serial number as the configuration database receive the download.	X
	Off	The MIS/C card does not download its configuration database (not recommended).	—
6	Off	Factory set. Do not change.	X
7 (Note 2)	On	Installed in a remote system or expansion shelf	—
	Off	Installed in a master shelf	X
8	Off	Factory set. Do not change.	X

Notes:

- Sections 1, 2, and 3 set the RS-232 baud rate and parity for COM2 only.
- To transfer information between an MIS/C card in a master system and an MIS/C card in a remote system, connect the COM 3 ports between the two master shelves.

Figure 4. MIS/C Card (090-44018-05) Switch

Chart 2. 090-44018-15 MIS/C Card Test

STEP	PROCEDURE
	<p>Use this procedure to install a 090-44018-15 MIS/C card (MIS/C ^{V5} card). After all of the cards in the shelf are installed, another procedure allows the 090-44018-15 MIS/C card to be the network management node for the DCD Shelf.</p> <p>Notes:</p> <ol style="list-style-type: none"> 1. See the TL1 User’s Guide for instructions about commands indicated in this procedure. 2. The standard MIS/C card allows communication with all three COM ports on the CEP as follows (all ports are set to 9600 baud at the factory, and function equally well if external equipment is set at even, odd, or no parity, 7 or 8 data bits, and 1 stop bit): <ul style="list-style-type: none"> COM1: Configurable for 1200 or 9600 baud via TL1 command only. COM2: Configurable for 1200 or 9600 baud, and even, odd, or no parity via switch setting only. COM3: Configurable for 1200 or 9600 baud via TL1 command only. 3. If a standard MIS/C card is removed from the shelf, COM1 and COM3 retain the configuration that was set via TL1 command. 4. If the Office Alarm and Shelf Status terminal sets have been connected to the office alarm system and remote telemetry equipment, the ohmmeter tests cannot be performed because the alarm systems apply -48 V at the alarm leads and ground on the return leads. To adequately test the standard MIS/C card, perform one of the following: <ol style="list-style-type: none"> a. Disconnect the office alarm system and remote telemetry equipment from the DCD-521/C Shelf to perform the ohmmeter tests, then reconnect the leads. b. Leave the office alarm system and remote telemetry equipment connections intact, and substitute the ohmmeter tests with audible and visual tests for appropriate condition responses from the office alarm system and verification of appropriate condition responses at the centralized alarm surveillance and control center. 5. After the INIT-SYS command is completed in this procedure, ignore any messages that may appear on the terminal until the last chart in this Test and Acceptance process. 6. Since no clock cards or clock input cards are installed, the CRITICAL alarm is active after the MIS/C card is installed. 7. The MINOR alarm lamp flashes when the standard MIS/C card checks the shelf and downloads the database. Wait for the lamp to stop flashing before continuing. <p>Test Equipment: Digital volt/ohm meter</p>
1	Set switch SW1 on the MIS/C card (see Figure 5) according to the factory settings.
2	If COM1 or COM3 are used, skip this step. Check the standard MIS/C card RS-232 settings to assure communications with the external terminal or computer (see Figure 5).
3	<p>When the RS-232 communications settings on the MIS/C card are correct, insert the MIS card into the slot labeled “MI” in the DCD-21/C master shelf.</p> <p>Requirement: The MIS/C card performs a lamp test, and the MINOR lamp flashes for up to 1 minute. The CRITICAL and MINOR lamps stay lit.</p>

Chart 2. 090-44018-15 MIS/C Card Test (Contd)

STEP	PROCEDURE
4	<p>Use the terminal to enter a semicolon and a carriage return.</p> <p>Requirement: The terminal displays a three-line message from the MIS/C as follows:</p> <pre style="margin-left: 40px;">TELECOM <date> <time> M <ctag> DENY ICNV ;</pre> <p>Where <date> and <time> are the date and time in the MIS/C card, <ctag> is a random number, and all upper-case letters are shown as they should appear. (See the appropriate TL1 User's Guide for TL1 language definitions.)</p>
5	<p>Use the INIT-SYS command with the appropriate <ph> value (see below and the TL1 User's Guide).</p> <p><ph> 3:</p> <ul style="list-style-type: none"> • Deletes all card information from the database • Retains all security information as previously entered, including the users and passwords • Retains the source ID (SID) as previously entered • Retains all communication parameters as previously entered <p><ph> 9:</p> <ul style="list-style-type: none"> • Deletes all card information from the database • Resets all security information to the factory settings • Resets the source ID (SID) to the factory settings, including only one user named "super" with a password of "sparky" • Resets all communication parameters to factory settings <p>Requirement: The terminal indicates a completed command.</p>
6	<p>Jumper the center and MAJ pins on the PWR ALM jumper block (JP1) on the CEP (see Figure 3).</p>
7	<p>Remove the -48V A fuse from the front panel of the shelf with a flat-blade screwdriver.</p> <p>Requirement: The red lamp under the -48V A fuse on the front panel front panel lights. On the MIS/C card, the MAJOR lamp lights red, the MINOR lamp lights yellow.</p>

Chart 2. 090-44018-15 MIS/C Card Test (Contd)

STEP	PROCEDURE																																																																		
8	<p>Connect the multimeter, set to resistance (for the MIN AUD, MIN VIS, MINSI, MAJ AUD, MAJ VIS, MAJSI, CRT AUD, CRT VIS, and CRTSI tests) or to volts dc (for the BATT ALM test) as appropriate, across the following Office Alarm pins and Shelf Status pins of J5 on the CEP (Figure 3):</p> <table border="1" data-bbox="331 528 1382 891"> <thead> <tr> <th>Type</th> <th>Test Point</th> <th>Pin#</th> <th>Test Point</th> <th>Pin#</th> <th>Result</th> </tr> </thead> <tbody> <tr> <td>Office Alarm</td> <td>MIN AUD NO</td> <td>45</td> <td>MIN AUD C</td> <td>20</td> <td><10 Ω</td> </tr> <tr> <td>Office Alarm</td> <td>MIN VIS NO</td> <td>21</td> <td>MIN VIS C</td> <td>47</td> <td><10 Ω</td> </tr> <tr> <td>Office Alarm</td> <td>MAJ AUD NO</td> <td>42</td> <td>MAJ AUD C</td> <td>13</td> <td><10 Ω</td> </tr> <tr> <td>Office Alarm</td> <td>MAJ VIS NO</td> <td>18</td> <td>MAJ VIS C</td> <td>44</td> <td><10 Ω</td> </tr> <tr> <td>Office Alarm</td> <td>CRT AUD NO</td> <td>39</td> <td>CRT AUD C</td> <td>14</td> <td><10 Ω</td> </tr> <tr> <td>Office Alarm</td> <td>CRT VIS NO</td> <td>15</td> <td>CRT VIS C</td> <td>41</td> <td><10 Ω</td> </tr> <tr> <td>Shelf Status</td> <td>MINSI</td> <td>11</td> <td>MINSR</td> <td>36</td> <td><10 Ω</td> </tr> <tr> <td>Shelf Status</td> <td>MAJSI</td> <td>12</td> <td>MAJSR</td> <td>37</td> <td><10 Ω</td> </tr> <tr> <td>Shelf Status</td> <td>CRTSI</td> <td>10</td> <td>CRTSR</td> <td>35</td> <td><10 Ω</td> </tr> <tr> <td>Shelf Status</td> <td>BATTALM</td> <td>13</td> <td>BATTRTN</td> <td>38</td> <td><0.1 V dc</td> </tr> </tbody> </table> <p>Note: When testing cards, it may be advantageous to have a 50-pin, male-to-male telco connector gender changer readily available for testing the leads on J5 and J6.</p> <p>Requirement: The multimeter indicates the readings shown in the Result column.</p>	Type	Test Point	Pin#	Test Point	Pin#	Result	Office Alarm	MIN AUD NO	45	MIN AUD C	20	<10 Ω	Office Alarm	MIN VIS NO	21	MIN VIS C	47	<10 Ω	Office Alarm	MAJ AUD NO	42	MAJ AUD C	13	<10 Ω	Office Alarm	MAJ VIS NO	18	MAJ VIS C	44	<10 Ω	Office Alarm	CRT AUD NO	39	CRT AUD C	14	<10 Ω	Office Alarm	CRT VIS NO	15	CRT VIS C	41	<10 Ω	Shelf Status	MINSI	11	MINSR	36	<10 Ω	Shelf Status	MAJSI	12	MAJSR	37	<10 Ω	Shelf Status	CRTSI	10	CRTSR	35	<10 Ω	Shelf Status	BATTALM	13	BATTRTN	38	<0.1 V dc
Type	Test Point	Pin#	Test Point	Pin#	Result																																																														
Office Alarm	MIN AUD NO	45	MIN AUD C	20	<10 Ω																																																														
Office Alarm	MIN VIS NO	21	MIN VIS C	47	<10 Ω																																																														
Office Alarm	MAJ AUD NO	42	MAJ AUD C	13	<10 Ω																																																														
Office Alarm	MAJ VIS NO	18	MAJ VIS C	44	<10 Ω																																																														
Office Alarm	CRT AUD NO	39	CRT AUD C	14	<10 Ω																																																														
Office Alarm	CRT VIS NO	15	CRT VIS C	41	<10 Ω																																																														
Shelf Status	MINSI	11	MINSR	36	<10 Ω																																																														
Shelf Status	MAJSI	12	MAJSR	37	<10 Ω																																																														
Shelf Status	CRTSI	10	CRTSR	35	<10 Ω																																																														
Shelf Status	BATTALM	13	BATTRTN	38	<0.1 V dc																																																														
9	<p>Press the ACO pushbutton on the MIS/C card.</p> <p>Requirement: The audible office alarm silences (if connected). On the MIS/C card, the ACO lamp lights green.</p>																																																																		
10	<p>Connect the multimeter, set to resistance (for the MINOR AUD, MINOR VIS, MINSI, MAJOR AUD, MAJOR VIS, and MAJSI tests) or to volts dc (for the BATT ALM test) as appropriate, across the following Office Alarm pins and Shelf Status pins of J5 on the CEP (Figure 3):</p> <table border="1" data-bbox="331 1346 1382 1615"> <thead> <tr> <th>Type</th> <th>Test Point</th> <th>Pin#</th> <th>Test Point</th> <th>Pin#</th> <th>Result</th> </tr> </thead> <tbody> <tr> <td>Office Alarm</td> <td>MIN AUD NO</td> <td>45</td> <td>MIN AUD C</td> <td>20</td> <td>>1 MΩ</td> </tr> <tr> <td>Office Alarm</td> <td>MIN VIS NO</td> <td>21</td> <td>MIN VIS C</td> <td>47</td> <td><10 Ω</td> </tr> <tr> <td>Office Alarm</td> <td>MAJ AUD NO</td> <td>42</td> <td>MAJ AUD C</td> <td>13</td> <td>>1 MΩ</td> </tr> <tr> <td>Office Alarm</td> <td>MAJ VIS NO</td> <td>18</td> <td>MAJ VIS C</td> <td>44</td> <td><10 Ω</td> </tr> <tr> <td>Shelf Status</td> <td>MINSI</td> <td>11</td> <td>MINSR</td> <td>36</td> <td><10 Ω</td> </tr> <tr> <td>Shelf Status</td> <td>MAJSI</td> <td>12</td> <td>MAJSR</td> <td>37</td> <td><10 Ω</td> </tr> <tr> <td>Shelf Status</td> <td>BATTALM</td> <td>13</td> <td>BATTRTN</td> <td>38</td> <td><0.1 V dc</td> </tr> </tbody> </table> <p>Requirement: The multimeter indicates the readings shown in the Result column.</p>	Type	Test Point	Pin#	Test Point	Pin#	Result	Office Alarm	MIN AUD NO	45	MIN AUD C	20	>1 MΩ	Office Alarm	MIN VIS NO	21	MIN VIS C	47	<10 Ω	Office Alarm	MAJ AUD NO	42	MAJ AUD C	13	>1 MΩ	Office Alarm	MAJ VIS NO	18	MAJ VIS C	44	<10 Ω	Shelf Status	MINSI	11	MINSR	36	<10 Ω	Shelf Status	MAJSI	12	MAJSR	37	<10 Ω	Shelf Status	BATTALM	13	BATTRTN	38	<0.1 V dc																		
Type	Test Point	Pin#	Test Point	Pin#	Result																																																														
Office Alarm	MIN AUD NO	45	MIN AUD C	20	>1 MΩ																																																														
Office Alarm	MIN VIS NO	21	MIN VIS C	47	<10 Ω																																																														
Office Alarm	MAJ AUD NO	42	MAJ AUD C	13	>1 MΩ																																																														
Office Alarm	MAJ VIS NO	18	MAJ VIS C	44	<10 Ω																																																														
Shelf Status	MINSI	11	MINSR	36	<10 Ω																																																														
Shelf Status	MAJSI	12	MAJSR	37	<10 Ω																																																														
Shelf Status	BATTALM	13	BATTRTN	38	<0.1 V dc																																																														
11	<p>Replace the -48V A fuse, using a flat-blade screwdriver to lock in place.</p> <p>Requirement: The -48V A fuse lamp goes off. On the MIS/C card, the MAJOR and MINOR lamps go off after up to 12 seconds, and the ACO lamp stays lit (because the CRITICAL alarm is active).</p>																																																																		

Chart 2. 090-44018-15 MIS/C Card Test (Contd)

STEP	PROCEDURE																																																
12	<p>Connect the multimeter, set to resistance (for the MINOR AUD, MINOR VIS, MINSI, MAJOR AUD, MAJOR VIS, and MAJSI tests) or to volts dc (for the BATT ALM test) as appropriate, across the following Office Alarm pins and Shelf Status pins of J5 on the CEP (Figure 3):</p> <table border="1" data-bbox="268 495 1385 763"> <thead> <tr> <th>Type</th> <th>Test Point</th> <th>Pin#</th> <th>Test Point</th> <th>Pin#</th> <th>Result</th> </tr> </thead> <tbody> <tr> <td>Office Alarm</td> <td>MIN AUD NO</td> <td>45</td> <td>MIN AUD C</td> <td>20</td> <td>>1 MΩ</td> </tr> <tr> <td>Office Alarm</td> <td>MIN VIS NO</td> <td>21</td> <td>MIN VIS C</td> <td>47</td> <td>>1 MΩ</td> </tr> <tr> <td>Office Alarm</td> <td>MAJ AUD NO</td> <td>42</td> <td>MAJ AUD C</td> <td>13</td> <td>>1 MΩ</td> </tr> <tr> <td>Office Alarm</td> <td>MAJ VIS NO</td> <td>18</td> <td>MAJ VIS C</td> <td>44</td> <td>>1 MΩ</td> </tr> <tr> <td>Shelf Status</td> <td>MINSI</td> <td>11</td> <td>MINSR</td> <td>36</td> <td>>1 MΩ</td> </tr> <tr> <td>Shelf Status</td> <td>MAJSI</td> <td>12</td> <td>MAJSR</td> <td>37</td> <td>>1 MΩ</td> </tr> <tr> <td>Shelf Status</td> <td>BATTALM</td> <td>13</td> <td>BATTRTN</td> <td>38</td> <td>-42 V dc to -56 V dc</td> </tr> </tbody> </table> <p>Requirement: The multimeter indicates the readings shown in the Result column.</p>	Type	Test Point	Pin#	Test Point	Pin#	Result	Office Alarm	MIN AUD NO	45	MIN AUD C	20	>1 MΩ	Office Alarm	MIN VIS NO	21	MIN VIS C	47	>1 MΩ	Office Alarm	MAJ AUD NO	42	MAJ AUD C	13	>1 MΩ	Office Alarm	MAJ VIS NO	18	MAJ VIS C	44	>1 MΩ	Shelf Status	MINSI	11	MINSR	36	>1 MΩ	Shelf Status	MAJSI	12	MAJSR	37	>1 MΩ	Shelf Status	BATTALM	13	BATTRTN	38	-42 V dc to -56 V dc
Type	Test Point	Pin#	Test Point	Pin#	Result																																												
Office Alarm	MIN AUD NO	45	MIN AUD C	20	>1 MΩ																																												
Office Alarm	MIN VIS NO	21	MIN VIS C	47	>1 MΩ																																												
Office Alarm	MAJ AUD NO	42	MAJ AUD C	13	>1 MΩ																																												
Office Alarm	MAJ VIS NO	18	MAJ VIS C	44	>1 MΩ																																												
Shelf Status	MINSI	11	MINSR	36	>1 MΩ																																												
Shelf Status	MAJSI	12	MAJSR	37	>1 MΩ																																												
Shelf Status	BATTALM	13	BATTRTN	38	-42 V dc to -56 V dc																																												
13	<p>Remove the -48V B fuse from the front panel on the DCD-521/C Shelf, using a flat-blade screwdriver.</p> <p>Requirement: The red lamp under the -48V B fuse on the front panel front panel lights. On the MIS/C card, the MAJOR lamp lights red, the MINOR lamp lights yellow, and the ACO lamp goes off. The the new alarm condition resets the ACO.</p>																																																
14	<p>Press the ACO pushbutton on the MIS/C card.</p> <p>Requirement: The audible office alarm silences (if connected). On the MIS/C card, the ACO lamp lights green.</p>																																																
15	<p>Replace the -48V B fuse, using a flat-blade screwdriver to lock in place.</p> <p>Requirement: The -48V B fuse lamp and the MIS/C MAJOR and MINOR lamps go off (after approximately 6 seconds to 12 seconds), and the ACO lamp stays lit (because the CRITICAL alarm is active).</p>																																																
16	<p>Remove both fuses from the front panel on the DCD-521/C Shelf, using a flat-blade screwdriver.</p> <p>Requirement: All lamps on the MIS/C card and shelf go out. The -48V A and -48V B lamps on the front panel light red.</p>																																																
17	<p>Replace both fuses, using a flat-blade screwdriver to lock in place.</p> <p>Requirement: The CRITICAL, MAJOR, and MINOR lamps on the MIS/C light, then go off, one at a time (the CRITICAL lamp lights to indicate there are no input and clock cards in the shelf). The -48V A and -48V B lamps are off on the front panel. The ACO lamp stays lit (because the CRITICAL alarm is active).</p>																																																
18	<p>Jumper the center and MIN pins on the PWR ALM jumper block (JP1) on the CEP (see Figure 3).</p>																																																

Chart 2. 090-44018-15 MIS/C Card Test (Contd)

STEP	PROCEDURE
19	<p>Remove fuse “-48V A” from the front panel on the DCD-521/C Shelf with a flat-blade screwdriver.</p> <p>Requirement: The red lamp under the -48V A fuse on the front panel lights, and the MINOR lamp on the MIS/C card lights yellow.</p>
20	<p>Press the ACO pushbutton on the MIS/C card.</p> <p>Requirement: The audible office alarm silences (if connected). On the MIS/C card, the ACO lamp lights green.</p>
21	<p>Replace the -48V A fuse, using a flat-blade screwdriver to lock in place.</p> <p>Requirement: The -48V A fuse lamp and MIS/C MINOR lamp go off, and the ACO lamp stays lit (because the CRITICAL alarm is active).</p>
22	<p>Remove the -48V B fuse from the front panel on the DCD-521/C Shelf, using a flat-blade screwdriver.</p> <p>Requirement: The red lamp under the -48V B fuse on the front panel front panel lights, and the MINOR lamp on the MIS/C card lights yellow. The ACO lamp on the MIS/C card goes off. The new alarm resets the ACO.</p>
23	<p>Press the ACO pushbutton on the MIS/C card.</p> <p>Requirement: The audible office alarm silences (if connected). On the MIS/C card, the ACO lamp lights green.</p>
24	<p>Replace the -48V B fuse, using a flat-blade screwdriver to lock in place.</p> <p>Requirement: The -48V B fuse lamp goes off, the MIS/C MINOR lamp goes off, and the ACO lamp stays lit (because the CRITICAL alarm is active).</p>
25	<p>Jumper the pins on the PWR ALM terminal block (JP1) on the CEP (see Figure 3) to conform to the requirements for this installation.</p>
26	<p>Repeat the previous steps in this procedure on each shelf which requires a 090-44018-15 MIS/C card.</p>
27	<p>This procedure is completed. Indicate completion of the 090-44018-15 MIS/C Card Test on the Test Sign-off form.</p>

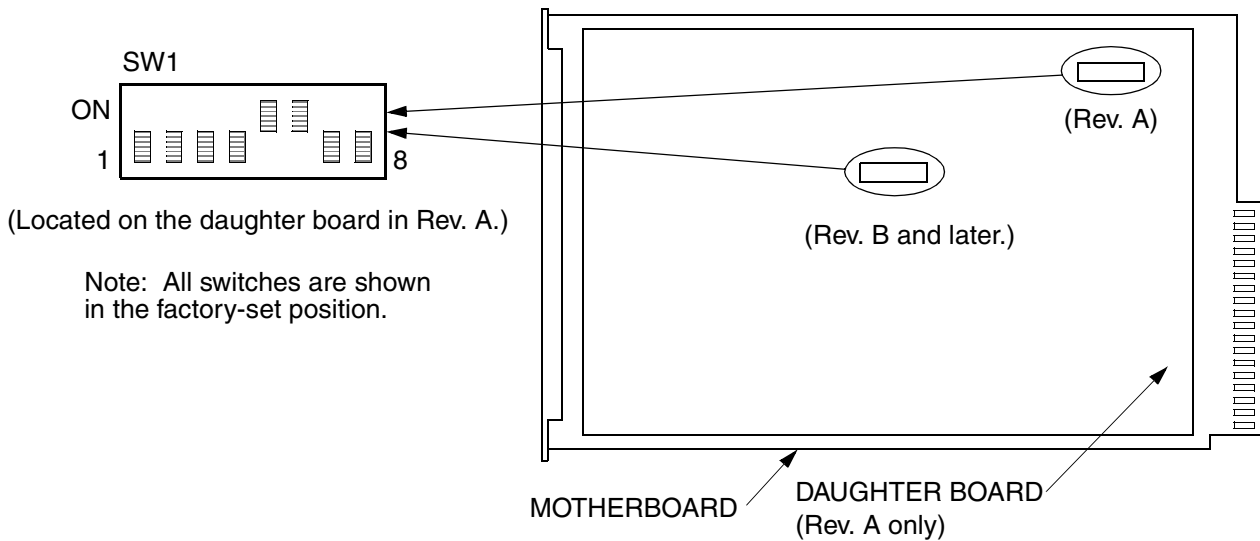

SW1 Switch Settings

SW1 Section	Position	Description	Factory Setting
1 (Note 1)	On	1200 Baud	—
	Off	9600 Baud	X
2 and 3 (Note 1)	2=on, 3=any	Odd Parity	—
	2=off, 3=on	Even Parity	—
	2=off, 3=off	No Parity	X
4	On	Password protection enabled	—
	Off	Password protection disabled	X
5	On	When power is applied (or recycled), the MIS/C card downloads its configuration database to the standard cards in the shelf. Only those standard cards in the same slot and with the same serial number as the configuration database receive the download.	X
	Off	The MIS/C card does not download its configuration database (not recommended).	—
6	On	Factory set. Do not change.	X
7 (Notes 2, 3)	On	Installed in a remote system or expansion shelf	—
	Off	Installed in a master shelf	X
8	Off	Factory set. Do not change.	X

Notes:

1. Sections 1, 2, and 3 set the RS-232 baud rate and parity for COM2 only.
2. If installing an MIS in a remote system, be sure the master-to-remote cable is not connected, and the expansion shelves are not connected.
3. To transfer information between an MIS/C card in a local system and an MIS/C card in a remote system, the MIS/C card in the local system master shelf must be connected to the MIS/C card in the remote system. Connect the COM 3 port on the local system master shelf to the COM3 port on the remote shelf.

Figure 5. 090-44018-15 MIS/C Card Switch

Chart 3. 090-44018-14 MIS/C Card Test

STEP	PROCEDURE
<p>Use this procedure to install an MIS/C (090-44018-14) card.</p> <p>Notes:</p> <ol style="list-style-type: none"> 1. The MIS/C card allows communication with all three COM ports on the CEP as follows (all ports are set to 9600 baud at the factory, and function equally well if external equipment is set at even, odd, or no parity, 7 or 8 data bits, and 1 stop bit): <ul style="list-style-type: none"> COM1: Configurable for 1200 or 9600 baud via TL1 command only. COM2: Configurable for 1200 or 9600 baud, and even, odd, or no parity via switch setting only. COM3: Configurable for 1200 or 9600 baud via TL1 command only. 2. If the MIS/C card is removed from the shelf, COM1 and COM3 do not retain a configuration that was set via TL1 command. 3. If the Office Alarm and Shelf Status terminal sets have been connected to the office alarm system and remote telemetry equipment, the ohmmeter tests cannot be performed because the alarm systems apply -48 V on the alarm leads and ground on the return leads. To adequately test the MIS/C card, perform one of the following: <ol style="list-style-type: none"> a. Disconnect the office alarm system and remote telemetry equipment from the DCD-521/C Shelf, and perform the ohmmeter tests, then reconnect the leads. b. Leave the office alarm system and remote telemetry equipment connections intact, and substitute the ohmmeter tests with audible and visual tests for appropriate condition responses from the office alarm system and verification of appropriate condition responses at the centralized alarm surveillance and control center. 4. Since no clock cards or clock input cards are installed, the CRITICAL alarm is active after the MIS/C card is installed. <p>Test Equipment: Digital volt/ohm meter</p>	
1	Set the sections of switch SW1 on the MIS/C card (see Figure 6) per the Installation Job Specifications.
2	Check the MIS/C card RS-232 settings to assure communications with the external terminal or computer (see Figure 6).
3	If the baud rate and parity for the communication device are correct, or if COM1 or COM3 are used, skip this step. Set SW1 on the MIS/C card's daughter board to the appropriate baud rate and parity for the communication device used (see Figure 6).
4	<p>When the RS-232 communications settings on the MIS/C card are correct, insert the MIS/C card into the slot labeled "MI" in the DCD-521/C master shelf.</p> <p>Requirement: The FAIL lamp on the MIS/C card lights and goes off, the CRITICAL lamp lights, and the MAJOR and MINOR lamps light and go off as a lamp test.</p>
5	Jumper the center and MAJ pins on the PWR ALM terminal block (JP1) on the CEP (see Figure 3).
6	<p>Remove the -48V A fuse from the front panel of the shelf with a flat-blade screwdriver.</p> <p>Requirement: The red lamp under the -48V A fuse on the front panel front panel lights. On the MIS/C card, the MAJOR lamp lights red and the MINOR lamp lights yellow.</p>

Chart 3. 090-44018-14 MIS/C Card Test (Contd)

STEP	PROCEDURE																																																																		
7	<p>Connect the multimeter, set to resistance (for the MIN AUD, MIN VIS, MINSI, MAJ AUD, MAJ VIS, MAJSI, CRT AUD, CRT VIS, and CRTSI tests) or to volts dc (for the BATT ALM test) as appropriate, across the following Office Alarm pins and Shelf Status pins of J5 on the CEP (Figure 3):</p> <table border="1" data-bbox="268 528 1348 891"> <thead> <tr> <th>Type</th> <th>Test Point</th> <th>Pin#</th> <th>Test Point</th> <th>Pin#</th> <th>Result</th> </tr> </thead> <tbody> <tr> <td>Office Alarm</td> <td>MIN AUD NO</td> <td>45</td> <td>MIN AUD C</td> <td>20</td> <td><10 Ω</td> </tr> <tr> <td>Office Alarm</td> <td>MIN VIS NO</td> <td>21</td> <td>MIN VIS C</td> <td>47</td> <td><10 Ω</td> </tr> <tr> <td>Office Alarm</td> <td>MAJ AUD NO</td> <td>42</td> <td>MAJ AUD C</td> <td>13</td> <td><10 Ω</td> </tr> <tr> <td>Office Alarm</td> <td>MAJ VIS NO</td> <td>18</td> <td>MAJ VIS C</td> <td>44</td> <td><10 Ω</td> </tr> <tr> <td>Office Alarm</td> <td>CRT AUD NO</td> <td>39</td> <td>CRT AUD C</td> <td>14</td> <td><10 Ω</td> </tr> <tr> <td>Office Alarm</td> <td>CRT VIS NO</td> <td>15</td> <td>CRT VIS C</td> <td>41</td> <td><10 Ω</td> </tr> <tr> <td>Shelf Status</td> <td>MINSI</td> <td>11</td> <td>MINSR</td> <td>36</td> <td><10 Ω</td> </tr> <tr> <td>Shelf Status</td> <td>MAJSI</td> <td>12</td> <td>MAJSR</td> <td>37</td> <td><10 Ω</td> </tr> <tr> <td>Shelf Status</td> <td>CRTSI</td> <td>10</td> <td>CRTSR</td> <td>35</td> <td><10 Ω</td> </tr> <tr> <td>Shelf Status</td> <td>BATTALM</td> <td>13</td> <td>BATTRTN</td> <td>38</td> <td><0.1 V dc</td> </tr> </tbody> </table> <p>Note: When testing cards, it may be advantageous to have a 50-pin, male-to-male telco connector gender changer readily available for testing the leads on J5 and J6.</p> <p>Requirement: The multimeter indicates the readings shown in the Result column.</p>	Type	Test Point	Pin#	Test Point	Pin#	Result	Office Alarm	MIN AUD NO	45	MIN AUD C	20	<10 Ω	Office Alarm	MIN VIS NO	21	MIN VIS C	47	<10 Ω	Office Alarm	MAJ AUD NO	42	MAJ AUD C	13	<10 Ω	Office Alarm	MAJ VIS NO	18	MAJ VIS C	44	<10 Ω	Office Alarm	CRT AUD NO	39	CRT AUD C	14	<10 Ω	Office Alarm	CRT VIS NO	15	CRT VIS C	41	<10 Ω	Shelf Status	MINSI	11	MINSR	36	<10 Ω	Shelf Status	MAJSI	12	MAJSR	37	<10 Ω	Shelf Status	CRTSI	10	CRTSR	35	<10 Ω	Shelf Status	BATTALM	13	BATTRTN	38	<0.1 V dc
Type	Test Point	Pin#	Test Point	Pin#	Result																																																														
Office Alarm	MIN AUD NO	45	MIN AUD C	20	<10 Ω																																																														
Office Alarm	MIN VIS NO	21	MIN VIS C	47	<10 Ω																																																														
Office Alarm	MAJ AUD NO	42	MAJ AUD C	13	<10 Ω																																																														
Office Alarm	MAJ VIS NO	18	MAJ VIS C	44	<10 Ω																																																														
Office Alarm	CRT AUD NO	39	CRT AUD C	14	<10 Ω																																																														
Office Alarm	CRT VIS NO	15	CRT VIS C	41	<10 Ω																																																														
Shelf Status	MINSI	11	MINSR	36	<10 Ω																																																														
Shelf Status	MAJSI	12	MAJSR	37	<10 Ω																																																														
Shelf Status	CRTSI	10	CRTSR	35	<10 Ω																																																														
Shelf Status	BATTALM	13	BATTRTN	38	<0.1 V dc																																																														
8	<p>Press the ACO pushbutton on the MIS/C card.</p> <p>Requirement: The audible office alarm silences (if connected). On the MIS/C card, the ACO lamp lights green.</p>																																																																		
9	<p>Connect the multimeter, set to resistance (for the MINOR AUD, MINOR VIS, MINSI, MAJOR AUD, MAJOR VIS, and MAJSI tests) or to volts dc (for the BATT ALM test) as appropriate, across the following Office Alarm pins and Shelf Status pins of J5 on the CEP (Figure 3):</p> <table border="1" data-bbox="268 1346 1348 1615"> <thead> <tr> <th>Type</th> <th>Test Point</th> <th>Pin#</th> <th>Test Point</th> <th>Pin#</th> <th>Result</th> </tr> </thead> <tbody> <tr> <td>Office Alarm</td> <td>MIN AUD NO</td> <td>45</td> <td>MIN AUD C</td> <td>20</td> <td>>1 MΩ</td> </tr> <tr> <td>Office Alarm</td> <td>MIN VIS NO</td> <td>21</td> <td>MIN VIS C</td> <td>47</td> <td><10 Ω</td> </tr> <tr> <td>Office Alarm</td> <td>MAJ AUD NO</td> <td>42</td> <td>MAJ AUD C</td> <td>13</td> <td>>1 MΩ</td> </tr> <tr> <td>Office Alarm</td> <td>MAJ VIS NO</td> <td>18</td> <td>MAJ VIS C</td> <td>44</td> <td><10 Ω</td> </tr> <tr> <td>Shelf Status</td> <td>MINSI</td> <td>11</td> <td>MINSR</td> <td>36</td> <td><10 Ω</td> </tr> <tr> <td>Shelf Status</td> <td>MAJSI</td> <td>12</td> <td>MAJSR</td> <td>37</td> <td><10 Ω</td> </tr> <tr> <td>Shelf Status</td> <td>BATTALM</td> <td>13</td> <td>BATTRTN</td> <td>38</td> <td><0.1 V dc</td> </tr> </tbody> </table> <p>Requirement: The multimeter indicates the readings shown in the Result column.</p>	Type	Test Point	Pin#	Test Point	Pin#	Result	Office Alarm	MIN AUD NO	45	MIN AUD C	20	>1 MΩ	Office Alarm	MIN VIS NO	21	MIN VIS C	47	<10 Ω	Office Alarm	MAJ AUD NO	42	MAJ AUD C	13	>1 MΩ	Office Alarm	MAJ VIS NO	18	MAJ VIS C	44	<10 Ω	Shelf Status	MINSI	11	MINSR	36	<10 Ω	Shelf Status	MAJSI	12	MAJSR	37	<10 Ω	Shelf Status	BATTALM	13	BATTRTN	38	<0.1 V dc																		
Type	Test Point	Pin#	Test Point	Pin#	Result																																																														
Office Alarm	MIN AUD NO	45	MIN AUD C	20	>1 MΩ																																																														
Office Alarm	MIN VIS NO	21	MIN VIS C	47	<10 Ω																																																														
Office Alarm	MAJ AUD NO	42	MAJ AUD C	13	>1 MΩ																																																														
Office Alarm	MAJ VIS NO	18	MAJ VIS C	44	<10 Ω																																																														
Shelf Status	MINSI	11	MINSR	36	<10 Ω																																																														
Shelf Status	MAJSI	12	MAJSR	37	<10 Ω																																																														
Shelf Status	BATTALM	13	BATTRTN	38	<0.1 V dc																																																														
10	<p>Replace the -48V A fuse, using a flat-blade screwdriver to lock in place.</p> <p>Requirement: The -48V A fuse lamp goes off. On the MIS/C card, the MAJOR and MINOR lamps go off after up to 12 seconds, and the ACO lamp stays lit (because the CRITICAL alarm is active).</p>																																																																		

Chart 3. 090-44018-14 MIS/C Card Test (Contd)

STEP	PROCEDURE																																																
11	<p>Connect the multimeter, set to resistance (for the MINOR AUD, MINOR VIS, MINSI, MAJOR AUD, MAJOR VIS, and MAJSI tests) or to volts dc (for the BATT ALM test) as appropriate, across the following Office Alarm pins and Shelf Status pins of J5 on the CEP (Figure 3):</p> <table border="1" data-bbox="331 495 1449 763"> <thead> <tr> <th>Type</th> <th>Test Point</th> <th>Pin#</th> <th>Test Point</th> <th>Pin#</th> <th>Result</th> </tr> </thead> <tbody> <tr> <td>Office Alarm</td> <td>MIN AUD NO</td> <td>45</td> <td>MIN AUD C</td> <td>20</td> <td>>1 MΩ</td> </tr> <tr> <td>Office Alarm</td> <td>MIN VIS NO</td> <td>21</td> <td>MIN VIS C</td> <td>47</td> <td>>1 MΩ</td> </tr> <tr> <td>Office Alarm</td> <td>MAJ AUD NO</td> <td>42</td> <td>MAJ AUD C</td> <td>13</td> <td>>1 MΩ</td> </tr> <tr> <td>Office Alarm</td> <td>MAJ VIS NO</td> <td>18</td> <td>MAJ VIS C</td> <td>44</td> <td>>1 MΩ</td> </tr> <tr> <td>Shelf Status</td> <td>MINSI</td> <td>11</td> <td>MINSR</td> <td>36</td> <td>>1 MΩ</td> </tr> <tr> <td>Shelf Status</td> <td>MAJSI</td> <td>12</td> <td>MAJSR</td> <td>37</td> <td>>1 MΩ</td> </tr> <tr> <td>Shelf Status</td> <td>BATTALM</td> <td>13</td> <td>BATTRTN</td> <td>38</td> <td>-42 V dc to -56 V dc</td> </tr> </tbody> </table> <p>Requirement: The multimeter indicates the readings shown in the Result column.</p>	Type	Test Point	Pin#	Test Point	Pin#	Result	Office Alarm	MIN AUD NO	45	MIN AUD C	20	>1 MΩ	Office Alarm	MIN VIS NO	21	MIN VIS C	47	>1 MΩ	Office Alarm	MAJ AUD NO	42	MAJ AUD C	13	>1 MΩ	Office Alarm	MAJ VIS NO	18	MAJ VIS C	44	>1 MΩ	Shelf Status	MINSI	11	MINSR	36	>1 MΩ	Shelf Status	MAJSI	12	MAJSR	37	>1 MΩ	Shelf Status	BATTALM	13	BATTRTN	38	-42 V dc to -56 V dc
Type	Test Point	Pin#	Test Point	Pin#	Result																																												
Office Alarm	MIN AUD NO	45	MIN AUD C	20	>1 MΩ																																												
Office Alarm	MIN VIS NO	21	MIN VIS C	47	>1 MΩ																																												
Office Alarm	MAJ AUD NO	42	MAJ AUD C	13	>1 MΩ																																												
Office Alarm	MAJ VIS NO	18	MAJ VIS C	44	>1 MΩ																																												
Shelf Status	MINSI	11	MINSR	36	>1 MΩ																																												
Shelf Status	MAJSI	12	MAJSR	37	>1 MΩ																																												
Shelf Status	BATTALM	13	BATTRTN	38	-42 V dc to -56 V dc																																												
12	<p>Remove the -48V B fuse from the front panel on the DCD-521/C Shelf, using a flat-blade screwdriver.</p> <p>Requirement: The red lamp under the -48V B fuse on the front panel front panel lights. On the MIS/C card, the MAJOR lamp lights red, the MINOR lamp lights yellow, and the ACO lamp goes off. The the new alarm condition resets the ACO.</p>																																																
13	<p>Press the ACO pushbutton on the MIS/C card.</p> <p>Requirement: The audible office alarm silences (if connected). On the MIS/C card, the ACO lamp lights green.</p>																																																
14	<p>Replace the -48V B fuse, using a flat-blade screwdriver to lock in place.</p> <p>Requirement: The -48V B fuse lamp and the MIS/C MAJOR and MINOR lamps go off (after approximately 6 seconds to 12 seconds), and the ACO lamp stays lit (because the CRITICAL alarm is active).</p>																																																
15	<p>Remove both fuses from the front panel on the DCD-521/C Shelf, using a flat-blade screwdriver.</p> <p>Requirement: All lamps on the MIS/C card and shelf go out. The -48V A and -48V B lamps on the front panel light red.</p>																																																
16	<p>Replace both fuses, using a flat-blade screwdriver to lock in place.</p> <p>Requirement: The CRITICAL, MAJOR, and MINOR lamps on the MIS/C light, then go off, one at a time (the CRITICAL lamp lights to indicate there are no input and clock cards in the shelf). The -48V A and -48V B lamps are off on the front panel. The ACO lamp stays lit (because the CRITICAL alarm is active).</p>																																																
17	<p>Jumper the center and MIN pins on the PWR ALM jumper block (JP1) on the CEP (see Figure 3).</p>																																																
18	<p>Remove fuse “-48V A” from the front panel on the DCD-521/C Shelf with a flat-blade screwdriver.</p> <p>Requirement: The red lamp under the -48V A fuse on the front panel lights, and the MINOR lamp on the MIS/C card lights yellow.</p>																																																

Chart 3. 090-44018-14 MIS/C Card Test (Contd)

STEP	PROCEDURE
19	<p>Press the ACO pushbutton on the MIS/C card.</p> <p>Requirement: The audible office alarm silences (if connected). On the MIS/C card, the ACO lamp lights green.</p>
20	<p>Replace the –48V A fuse, using a flat-blade screwdriver to lock in place.</p> <p>Requirement: The –48V A fuse lamp and MIS/C MINOR lamp go off, and the ACO lamp stays lit (because the CRITICAL alarm is active).</p>
21	<p>Remove the –48V B fuse from the front panel on the DCD-521/C Shelf, using a flat-blade screwdriver.</p> <p>Requirement: The red lamp under the –48V B fuse on the front panel front panel lights, and the MINOR lamp on the MIS/C card lights yellow. The ACO lamp on the MIS/C card goes off. The new alarm resets the ACO.</p>
22	<p>Press the ACO pushbutton on the MIS/C card.</p> <p>Requirement: The audible office alarm silences (if connected). On the MIS/C card, the ACO lamp lights green.</p>
23	<p>Replace the –48V B fuse, using a flat-blade screwdriver to lock in place.</p> <p>Requirement: The –48V B fuse lamp goes off, the MIS/C MINOR lamp goes off, and the ACO lamp stays lit (because the CRITICAL alarm is active).</p>
24	<p>Jumper the pins on the PWR ALM terminal block (JP1) on the CEP (see Figure 3) to conform to the requirements for this installation.</p>
25	<p>Repeat the previous steps in this procedure on each shelf which requires a 090-44018-14 MIS/C card.</p>
26	<p>This procedure is completed. Indicate completion of the 090-44018-14 MIS/C Card Test on the Test Sign-off form.</p>

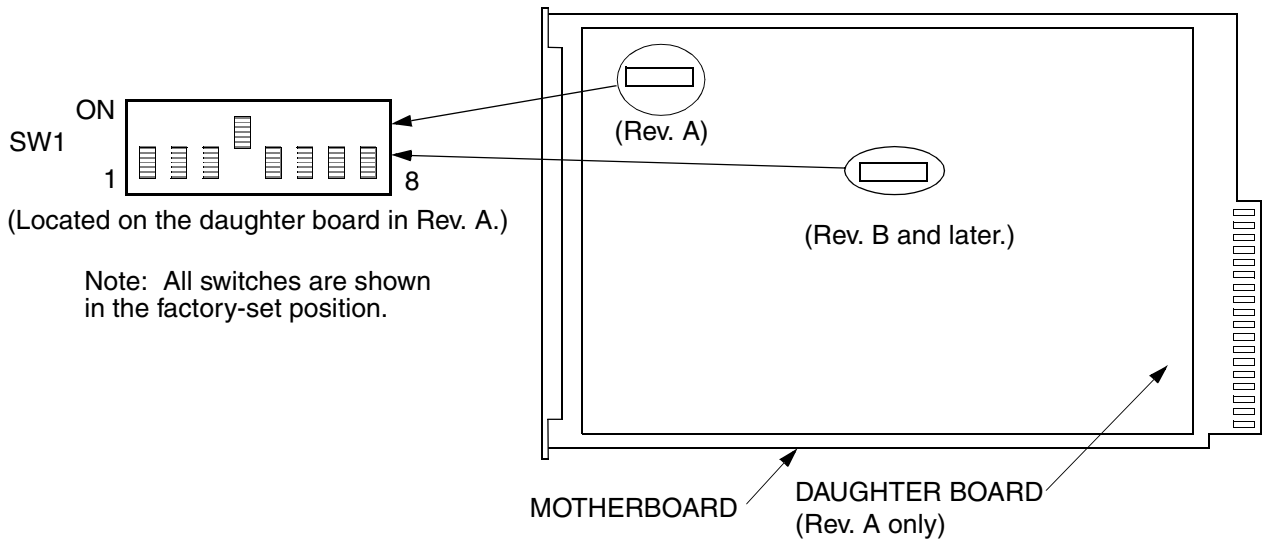

SW1 Switch Settings

SW1 Section	Position	Description	Factory Setting
1 (Note 1)	On	1200 baud	—
	Off	9600 baud	X
2 and 3 (Note 1)	2=on, 3=any	Odd parity	—
	2=off, 3=on	Even parity	—
	2=off, 3=off	No parity	X
4	On	Password protection disabled	X
	Off	Password protection enabled	—
5 and 6	Off	Not used. Do not change.	X
7	On	Installed in a remote system or expansion shelf (Note 2)	—
	Off	Installed in a master shelf	X
8	Off	Not used. Do not change.	X

Notes:

- Sections 1, 2, and 3 set the RS-232 baud rate and parity for COM2 only.
- TL1 commands determine whether the MIS/C card is in a remote system or an expansion shelf.

Figure 6. 090-44018-14 MIS/C Card Switch

Chart 4. SAI/C Card Test

STEP	PROCEDURE																																																
	<p>Use this procedure to test the SAI/C card.</p> <p>Notes:</p> <ol style="list-style-type: none"> 1. There are no switch or jumper settings for the SAI/C card. 2. When checking relay contact status, refer to Figure 3 for the location of J5. 3. If the Office Alarm and Shelf Status terminal sets have been connected to the office alarm system and remote telemetry equipment, the ohmmeter tests cannot be performed because these systems apply -48 V on the alarm leads and ground on the return leads. To adequately test the SAI/C card, perform one of the following: <ol style="list-style-type: none"> a. Disconnect the office alarm system and remote telemetry equipment from the DCD-521/C Shelf, perform the ohmmeter tests, then reconnect the leads. b. Leave the office alarm system and remote telemetry equipment connections intact, and substitute the ohmmeter tests with audible and visual tests for appropriate condition responses from the office alarm system and verification of appropriate condition responses at the centralized alarm surveillance and control center. <p>Test Equipment: Digital multimeter</p>																																																
1	<p>Insert the SAI/C card into the slot labeled “MI” in the DCD-521/C master shelf.</p> <p>Requirement: The MAJOR and MINOR lamps on the SAI/C card light and go off one at a time.</p>																																																
2	<p>On the PWR ALM jumpers (JP1) on the CEP, strap the center pin to the MAJ pin (see Figure 3).</p>																																																
3	<p>Remove fuse “-48V A” from the DCD-521/C Shelf with a flat-blade screwdriver.</p> <p>Requirement: The red lamp under the -48V A fuse on the front panel lights. On the SAI/C card, the MAJOR lamp lights red, the MINOR lamp lights yellow, and the ACO lamp goes off.</p>																																																
4	<p>Connect the multimeter, set to the resistance scale, across the following Office Alarm pins and Shelf Status pins of J5 on the CEP (Figure 3):</p> <table border="1" data-bbox="268 1384 1316 1659"> <thead> <tr> <th>Type</th> <th>Test Point</th> <th>Pin#</th> <th>Test Point</th> <th>Pin#</th> <th>Result</th> </tr> </thead> <tbody> <tr> <td>Office Alarm</td> <td>MIN AUD NO</td> <td>45</td> <td>MIN AUD C</td> <td>20</td> <td><10 Ω</td> </tr> <tr> <td>Office Alarm</td> <td>MIN VIS NO</td> <td>21</td> <td>MIN VIS C</td> <td>47</td> <td><10 Ω</td> </tr> <tr> <td>Office Alarm</td> <td>MAJ AUD NO</td> <td>42</td> <td>MAJ AUD C</td> <td>13</td> <td><10 Ω</td> </tr> <tr> <td>Office Alarm</td> <td>MAJ VIS NO</td> <td>18</td> <td>MAJ VIS C</td> <td>44</td> <td><10 Ω</td> </tr> <tr> <td>Shelf Status</td> <td>MINSI</td> <td>11</td> <td>MINSR</td> <td>36</td> <td><10 Ω</td> </tr> <tr> <td>Shelf Status</td> <td>MAJSI</td> <td>12</td> <td>MAJSR</td> <td>37</td> <td><10 Ω</td> </tr> <tr> <td>Shelf Status</td> <td>BATTALM</td> <td>13</td> <td>BATTRTN</td> <td>38</td> <td><10 Ω</td> </tr> </tbody> </table> <p>Requirement: The multimeter indicates the readings shown in the Result column.</p>	Type	Test Point	Pin#	Test Point	Pin#	Result	Office Alarm	MIN AUD NO	45	MIN AUD C	20	<10 Ω	Office Alarm	MIN VIS NO	21	MIN VIS C	47	<10 Ω	Office Alarm	MAJ AUD NO	42	MAJ AUD C	13	<10 Ω	Office Alarm	MAJ VIS NO	18	MAJ VIS C	44	<10 Ω	Shelf Status	MINSI	11	MINSR	36	<10 Ω	Shelf Status	MAJSI	12	MAJSR	37	<10 Ω	Shelf Status	BATTALM	13	BATTRTN	38	<10 Ω
Type	Test Point	Pin#	Test Point	Pin#	Result																																												
Office Alarm	MIN AUD NO	45	MIN AUD C	20	<10 Ω																																												
Office Alarm	MIN VIS NO	21	MIN VIS C	47	<10 Ω																																												
Office Alarm	MAJ AUD NO	42	MAJ AUD C	13	<10 Ω																																												
Office Alarm	MAJ VIS NO	18	MAJ VIS C	44	<10 Ω																																												
Shelf Status	MINSI	11	MINSR	36	<10 Ω																																												
Shelf Status	MAJSI	12	MAJSR	37	<10 Ω																																												
Shelf Status	BATTALM	13	BATTRTN	38	<10 Ω																																												
5	<p>Press the ACO pushbutton on the SAI/C card.</p> <p>Requirement: The audible office alarm silences (if connected). On the SAI/C card, the ACO lamp lights green.</p>																																																

Chart 4. SAI/C Card Test (Contd)

STEP	PROCEDURE																																																
6	<p>Connect the multimeter, set to the resistance scale, across the following Office Alarm pins and Shelf Status pins of J5 on the CEP (Figure 3):</p> <table border="1" data-bbox="331 465 1390 734"> <thead> <tr> <th>Type</th> <th>Test Point</th> <th>Pin#</th> <th>Test Point</th> <th>Pin#</th> <th>Result</th> </tr> </thead> <tbody> <tr> <td>Office Alarm</td> <td>MIN AUD NO</td> <td>45</td> <td>MIN AUD C</td> <td>20</td> <td>>1 MΩ</td> </tr> <tr> <td>Office Alarm</td> <td>MIN VIS NO</td> <td>21</td> <td>MIN VIS C</td> <td>47</td> <td><10 Ω</td> </tr> <tr> <td>Office Alarm</td> <td>MAJ AUD NO</td> <td>42</td> <td>MAJ AUD C</td> <td>13</td> <td>>1 MΩ</td> </tr> <tr> <td>Office Alarm</td> <td>MAJ VIS NO</td> <td>18</td> <td>MAJ VIS C</td> <td>44</td> <td><10 Ω</td> </tr> <tr> <td>Shelf Status</td> <td>MINSI</td> <td>11</td> <td>MINSR</td> <td>36</td> <td><10 Ω</td> </tr> <tr> <td>Shelf Status</td> <td>MAJSI</td> <td>12</td> <td>MAJSR</td> <td>37</td> <td><10 Ω</td> </tr> <tr> <td>Shelf Status</td> <td>BATTALM</td> <td>13</td> <td>BATTRTN</td> <td>38</td> <td><10 Ω</td> </tr> </tbody> </table> <p>Requirement: The multimeter indicates the readings shown in the Result column.</p>	Type	Test Point	Pin#	Test Point	Pin#	Result	Office Alarm	MIN AUD NO	45	MIN AUD C	20	>1 MΩ	Office Alarm	MIN VIS NO	21	MIN VIS C	47	<10 Ω	Office Alarm	MAJ AUD NO	42	MAJ AUD C	13	>1 MΩ	Office Alarm	MAJ VIS NO	18	MAJ VIS C	44	<10 Ω	Shelf Status	MINSI	11	MINSR	36	<10 Ω	Shelf Status	MAJSI	12	MAJSR	37	<10 Ω	Shelf Status	BATTALM	13	BATTRTN	38	<10 Ω
Type	Test Point	Pin#	Test Point	Pin#	Result																																												
Office Alarm	MIN AUD NO	45	MIN AUD C	20	>1 MΩ																																												
Office Alarm	MIN VIS NO	21	MIN VIS C	47	<10 Ω																																												
Office Alarm	MAJ AUD NO	42	MAJ AUD C	13	>1 MΩ																																												
Office Alarm	MAJ VIS NO	18	MAJ VIS C	44	<10 Ω																																												
Shelf Status	MINSI	11	MINSR	36	<10 Ω																																												
Shelf Status	MAJSI	12	MAJSR	37	<10 Ω																																												
Shelf Status	BATTALM	13	BATTRTN	38	<10 Ω																																												
7	<p>Replace the -48V A fuse, using a flat-blade screwdriver to lock in place.</p> <p>Requirement: -48V A fuse lamp lights. On the SAI/C card, the MAJOR lamp lights red, the MINOR lamp lights yellow, and the ACO lamp goes off.</p>																																																
8	<p>Connect the multimeter, set to the resistance scale, across the following Office Alarm pins and Shelf Status pins of J5 on the CEP (Figure 3):</p> <table border="1" data-bbox="331 1059 1390 1328"> <thead> <tr> <th>Type</th> <th>Test Point</th> <th>Pin#</th> <th>Test Point</th> <th>Pin#</th> <th>Result</th> </tr> </thead> <tbody> <tr> <td>Office Alarm</td> <td>MIN AUD NO</td> <td>45</td> <td>MIN AUD C</td> <td>20</td> <td>>1 MΩ</td> </tr> <tr> <td>Office Alarm</td> <td>MIN VIS NO</td> <td>21</td> <td>MIN VIS C</td> <td>47</td> <td>>1 MΩ</td> </tr> <tr> <td>Office Alarm</td> <td>MAJ AUD NO</td> <td>42</td> <td>MAJ AUD C</td> <td>13</td> <td>>1 MΩ</td> </tr> <tr> <td>Office Alarm</td> <td>MAJ VIS NO</td> <td>18</td> <td>MAJ VIS C</td> <td>44</td> <td>>1 MΩ</td> </tr> <tr> <td>Shelf Status</td> <td>MINSI</td> <td>11</td> <td>MINSR</td> <td>36</td> <td>>1 MΩ</td> </tr> <tr> <td>Shelf Status</td> <td>MAJSI</td> <td>12</td> <td>MAJSR</td> <td>37</td> <td>>1 MΩ</td> </tr> <tr> <td>Shelf Status</td> <td>BATTALM</td> <td>13</td> <td>BATTRTN</td> <td>38</td> <td>>1 MΩ</td> </tr> </tbody> </table> <p>Requirement: The multimeter indicates the readings shown in the Result column.</p>	Type	Test Point	Pin#	Test Point	Pin#	Result	Office Alarm	MIN AUD NO	45	MIN AUD C	20	>1 MΩ	Office Alarm	MIN VIS NO	21	MIN VIS C	47	>1 MΩ	Office Alarm	MAJ AUD NO	42	MAJ AUD C	13	>1 MΩ	Office Alarm	MAJ VIS NO	18	MAJ VIS C	44	>1 MΩ	Shelf Status	MINSI	11	MINSR	36	>1 MΩ	Shelf Status	MAJSI	12	MAJSR	37	>1 MΩ	Shelf Status	BATTALM	13	BATTRTN	38	>1 MΩ
Type	Test Point	Pin#	Test Point	Pin#	Result																																												
Office Alarm	MIN AUD NO	45	MIN AUD C	20	>1 MΩ																																												
Office Alarm	MIN VIS NO	21	MIN VIS C	47	>1 MΩ																																												
Office Alarm	MAJ AUD NO	42	MAJ AUD C	13	>1 MΩ																																												
Office Alarm	MAJ VIS NO	18	MAJ VIS C	44	>1 MΩ																																												
Shelf Status	MINSI	11	MINSR	36	>1 MΩ																																												
Shelf Status	MAJSI	12	MAJSR	37	>1 MΩ																																												
Shelf Status	BATTALM	13	BATTRTN	38	>1 MΩ																																												
9	<p>Remove the -48V B fuse from the DCD-521/C Shelf, using a flat-blade screwdriver.</p> <p>Requirement: The red lamp under the -48V B fuse on the front panel lights. The SAI/C MAJOR and MINOR lamps light red and yellow, respectively. The ACO lamp on the SAI/C card goes off. The new alarm resets the ACO.</p>																																																
10	<p>Press the ACO pushbutton on the SAI/C card.</p> <p>Requirement: The audible office alarm silences (if connected). On the SAI/C card, the ACO lamp lights green.</p>																																																
11	<p>Replace the -48V B fuse, using a flat-blade screwdriver to lock in place.</p> <p>Requirement: The red lamp under the -48V B fuse on the front panel goes off. The SAI/C MAJOR and MINOR lamps go off (after approximately 6 seconds to 12 seconds).</p>																																																

Chart 4. SAI/C Card Test (Contd)

STEP	PROCEDURE
12	<p>Remove both fuses from the DCD-521/C Shelf, using a flat-blade screwdriver to lock in place.</p> <p>Requirement: The red lamps under the –48V A and B fuses on the front panel light. All lamps on the SAI/C card and shelf go off. The new alarm condition resets the ACO.</p>
13	<p>Press the ACO pushbutton on the SAI/C card.</p> <p>Requirement: The audible office alarm silences (if connected).</p>
14	<p>Replace both fuses, using a flat-blade screwdriver to lock in place.</p> <p>Requirement: The MAJOR and MINOR lamps on the SAI/C light and then go off, one at a time. The –48V A and –48V B lamps are off under the fuses.</p>
15	<p>On the PWR ALM jumpers (JP1) on the CEP, strap the center pin to the MIN pin (see Figure 3).</p>
16	<p>Remove fuse “–48V A” from the DCD-521/C Shelf with a flat-blade screwdriver.</p> <p>Requirement: The red lamp under the –48V A fuse on the front panel lights, and the MINOR lamp on the SAI/C card lights yellow.</p>
17	<p>Press the ACO pushbutton on the SAI/C card.</p> <p>Requirement: The audible office alarm silences (if connected). On the SAI/C card, the ACO lamp lights green.</p>
18	<p>Replace the –48V A fuse, using a flat-blade screwdriver to lock in place.</p> <p>Requirement: The –48V B fuse lamp and the SAI/C MINOR lamps go off.</p>
19	<p>Remove the –48V B fuse from the DCD-521/C Shelf, using a flat-blade screwdriver.</p> <p>Requirement: The red lamp under the –48V B fuse on the front panel lights, and the MINOR lamp on the SAI/C card lights yellow.</p>
20	<p>Press the ACO pushbutton on the SAI/C card.</p> <p>Requirement: The audible office alarm silences (if connected). On the SAI/C card, the ACO lamp lights green.</p>
21	<p>Replace the –48V B fuse, using a flat-blade screwdriver to lock in place.</p> <p>Requirement: The –48V B fuse lamp and the SAI/C MINOR lamps go off.</p>
22	<p>Jumper the pins on the PWR ALM terminal block (JP1) on the CEP (see Figure 3) to conform to the requirements for this installation.</p>
23	<p>Repeat the previous steps in this procedure on each shelf which requires an SAI/C card.</p>
24	<p>This procedure is completed. Indicate completion of the SAI/C Card Test on the Test Sign-off form.</p>

Chart 5. MRC/C Card Test

STEP	PROCEDURE
<p>Use this procedure to install the MRC/C cards. This procedure assumes the input reference signals have been connected per the Installation section of this manual.</p> <p>Note: Clock cards are inserted in the master shelf in Step 1 for testing the MRC/C cards. Clock cards for this installation are installed in a separate chart later in this section.</p> <p>Test Equipment: None</p>	
1	<p>For test purposes, insert the clock cards (TNC-E/C, TNC/C, or LNC/C) that conform to the requirements for this installation into the master shelf of the system.</p> <p>Note: If installing a TNC-E/C and TNC/C or LNC/C card clock card combination, it is imperative that the TNC-E/C be installed first and allowed to stabilize before installing the TNC/C. Failure to allow the TNC-E/C to stabilize results in incorrect timing from the clock cards.</p>
2	<p>Observe the lamps on the clock cards.</p> <p>Requirement: On the TNC/C or LNC/C cards: the FREE RUN lamp lights green (steady), and the ACTIVE lamp is lit green after the warm-up (stabilization) period. On the TNC-E/C cards: the HOLD OVER lamp lights green (steady), and the ACTIVE lamp lights green after the warm-up (stabilization) period.</p>
3	<p>On the master shelf CEP, set the TNCE/TNC switch to the TNCE position.</p> <p>Note: Only those clock card lamps that are identified in the Requirements paragraphs of this procedure are applicable to this test.</p>
4	<p>Set switches SW1 and SW3 on the MRC/C card to conform to the requirements for this installation (refer to Figure 7, Table D, Table E, and Table F) per Installation Job Specifications.</p> <p>Note: CRC4 framing for the MRC-EA/C cards is selectable via TL1 commands through the MIS/C card only; CRC4 framing is set by the software to be enabled. Refer to the TL1 User's Guide for instructions.</p>
5	<p>If not equipped with a second MRC/C card, skip this step. Repeat the previous step for the second MRC/C card.</p>
6	<p>Insert an MRC/C card into the MR A slot in the master shelf, insert the second MRC/C card into the MR B slot if using two, and wait 3 minutes.</p> <p>Requirement: When first installed, the MRC/C performs a lamp test and qualifies equipped input signals. After 3 minutes, REF lamps for enabled inputs are lit red when an input signal is not present, and green when a valid input signal is present. The STATUS lamp for the active input is lit green; all other STATUS lamps are off.</p>
7	<p>Observe the MRC/C card lamps 10 minutes after inserting an MRC/C card into the shelf.</p> <p>Requirement: The FAIL lamp is off, the REF lamps for the enabled inputs are lit green, and the REF lamps for the disabled inputs are off. The SRC ACTIVE lamp on the card in the MR A slot is lit green. The STATUS lamp for the active (highest-priority) input is lit green; all others are off. Do not proceed to the next step until these requirements are met.</p>

Chart 5. MRC/C Card Test (Contd)

STEP	PROCEDURE
8	<p>Observe the clock lamps.</p> <p>Requirement: On both clocks: the LKD or LOCKED lamp is lit green, the ACTIVE lamp is lit green. The SRC A lamp on the card in the TNC A slot is lit green. The SRC B lamp on the card in the TNC B slot is lit green.</p>
9	<p>If not equipped with a second MRC/C card, go to Step 11. Press and hold the XFR pushbutton for approximately 2 seconds, and release.</p> <p>Requirement: The SRC ACTIVE lamp on the card in MR B lights, and the SRC ACTIVE lamp on the card in MR A goes off.</p>
10	<p>Press and hold the XFR pushbutton for approximately 2 seconds, and release.</p> <p>Requirement: The SRC ACTIVE lamp on the card in MR B lights, and the SRC ACTIVE lamp on the card in MR A goes off.</p>
11	<p>On the CEP, locate the highest-priority input to the MRC/C card in the MR A slot and perform one of the following:</p> <p>If using a wire-wrap module, short the T and R leads with a short clip lead (Š6 in).</p> <p>If using a coaxial module, remove the connector from the input module to remove the signal.</p> <p>Requirement: On the MRC/C card, the REF lamp for the shorted or removed input is lit red, and the adjacent STATUS lamp is off. The STATUS lamp for the second priority input is lit green. On the MIS/C card, the MINOR lamp is lit yellow.</p> <p>If the last valid input has been shorted or removed in this step, in addition, the SRC ACTIVE lamp on the MRC/C card in the MR A slot goes off, and the SRC ACTIVE lamp on the MRC/C card in the MR B slot lights. On the MIS/C card, the MAJOR lamp is lit red.</p> <p>Note: Do not remove shorting jumpers or reinstall coaxial connectors until directed.</p>

Chart 5. MRC/C Card Test (Contd)

STEP	PROCEDURE
12	Repeat the previous step for each remaining input in descending order of priority (refer to Figure 7) on the MRC/C card in the MR B slot.
13	<p>Remove all shorting jumpers and reinstall all coaxial connectors (positioned in Steps 11 and 12) at the reference input modules on the CEP.</p> <p>Requirement: On the installed MRC/C cards, the FAIL lamp is off, the REF lamps for the enabled inputs are lit green and the REF lamps for the disabled inputs are off. The SRC ACTIVE lamp on the card in the MR A slot is lit green. The STATUS lamp for the active (highest-priority) input is lit green, all others are off. On the MIS/C card, all lamps are off. Do not proceed to the next step until these requirements are met.</p>
14	If not equipped with a second MRC/C card, skip this step. If equipped with a second MRC/C card, repeat Steps 11 through 13 for the MRC/C card in the MR B slot.
15	<p>Set the TNCE/TNC switch (SW1) on the CEP (Figure 3) to conform to the requirements for this installation: The TNCE position sets the master shelf for operation with rubidium (TNC-E/C) clock cards, and 090-44010-08, -09, -57, and -57T MRC/C cards. The TNC position sets the master shelf for operation with quartz (TNC/C or LNC/C) clock cards, unless a TNCE/C card is also installed.</p> <p>Requirement: If equipped with a second MRC/C card and the switch is in the TNCE position, the SRC ACTIVE lamps on both MRC/C cards are lit. The transfer (XFR) function between the MRC/C cards is disabled.</p>
16	<p>If an SAI/C card is installed in the shelf, skip this step. Use the INIT-REG command for every MRC/C card in the shelf. This initializes all registers on the shelf.</p> <p>Requirement: The response indicates the command was completed successfully.</p>
17	This procedure is completed. Indicate completion of the MRC/C Card Test on the Test Sign-off form.

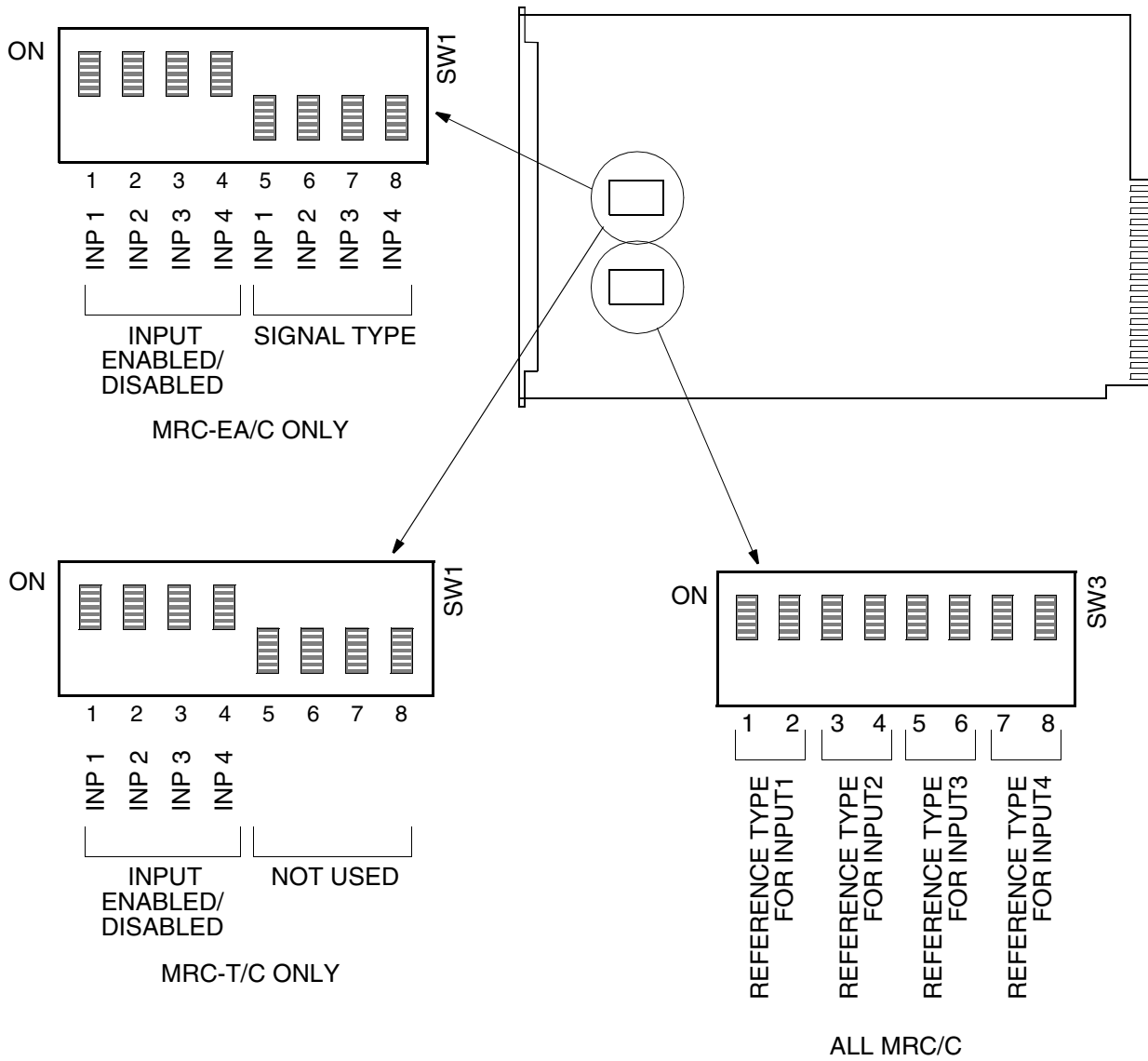

Note: All switches are shown in the factory-set position.

Figure 7. MRC/C Card Switch

Table D. MRC-EA/C Card SW1 Settings

SECTION	POSITION	MEANING	FACTORY SETTING
1	ON	Input 1 enabled	X
	OFF	Input 1 disabled	—
2	ON	Input 2 enabled	X
	OFF	Input 2 disabled	—
3	ON	Input 3 enabled	X
	OFF	Input 3 disabled	—
4	ON	Input 4 enabled	X
	OFF	Input 4 disabled	—
5	ON	Input 1 - Analog	—
	OFF	Input 1 - E1	X
6	ON	Input 2 - Analog	—
	OFF	Input 2 - E1	X
7	ON	Input 3 - Analog	—
	OFF	Input 3 - E1	X
8	ON	Input 4 - Analog	—
	OFF	Input 4 - E1	X

Table E. MRC-T /C Card Switch SW1 Settings

SECTION	POSITION	MEANING	FACTORY SETTING
1	ON	Input 1 enabled	X
	OFF	Input 1 disabled	—
2	ON	Input 2 enabled	X
	OFF	Input 2 disabled	—
3	ON	Input 3 enabled	X
	OFF	Input 3 disabled	—
4	ON	Input 4 enabled	X
	OFF	Input 4 disabled	—
5–8	OFF	Not Used	X

Table F. MRC/C Card Switch SW3 Settings

REFERENCE TYPE CONNECTED TO INPUT	SECTIONS 1 & 2 (FOR INPUT 1)		SECTIONS 3 & 4 (FOR INPUT 2)		SECTIONS 5 & 6 (FOR INPUT 3)		SECTIONS 7 & 8 (FOR INPUT 4)		FACTORY SETTING
	1	2	3	4	5	6	7	8	
Network	ON	ON	ON	ON	ON	ON	ON	ON	X
LORAN	ON	OFF	ON	OFF	ON	OFF	ON	OFF	—
GPS	OFF	ON	OFF	ON	OFF	ON	OFF	ON	—
Cesium	OFF	OFF	OFF	OFF	OFF	OFF	OFF	OFF	—

Note: The sections of SW3 are used to identify the reference type connected to each input. Example: If the reference type on input 1 is Cesium, set positions 1 and 2 of SW3 to OFF.

Chart 6. ACI/C Card Test

STEP	PROCEDURE
	<p>Use this procedure to install ACI/C cards. This procedure assumes the input reference signals have been connected per the Installation section of this manual. Consult the local company Installation Job Specifications to determine the type of input card to be installed in the MRA and MRB slots in the shelf.</p> <p>Note: If installing an ACI/C card in a remote system, contact your local Symmetricom distributor or Symmetricom's CTAC.</p> <p>Test Equipment: None</p>
1	<p>On the master shelf CEP, set the TNCE/TNC switch (Figure 3) to the TNC position for this test, regardless of the type of clock card to be installed.</p>
2	<p>Set sections 1 and 2 of switch SW4 (Figure 8) on each ACI/C card to be installed to match the frequency of the input reference signal.</p>
3	<p>Insert an ACI/C card into the MR A slot in the master shelf.</p> <p>Requirement: On the ACI/C card just installed, the FAIL lamp and SRC FAIL lamps are lit red. Both lamps go off approximately 20 seconds after the card is installed. After the card has warmed up, the SRC ACT lamp is lit green.</p>
4	<p>If not equipped with a second ACI/C card, skip this step. Insert the second ACI/C card into the MR B slot in the master shelf.</p> <p>Requirement: On the ACI/C card just installed, the FAIL lamp and SRC FAIL lamps are lit red. Both lamps go off approximately 20 seconds after the card is installed. After the card has warmed up, the SRC ACT lamp remains off.</p>
5	<p>Press the XFR pushbutton on one of the ACI/C cards.</p> <p>Requirement: The lit SRC ACT lamp transfers to the other ACI/C card.</p>
6	<p>Press the XFR pushbutton on the other ACI/C card.</p> <p>Requirement: The lit SRC ACT lamp lights on the original ACI/C card.</p>
7	<p>Remove the ACI/C card with its SRC ACT lamp lit.</p> <p>Requirement: The SRC ACT lamp lights on the other ACI/C card.</p>

Chart 6. ACI/C Card Test (Contd)

STEP	PROCEDURE
8	<p>Reinsert the removed ACI/C card.</p> <p>Requirement: The SRC ACT lamp remains lit on the other ACI/C card.</p>
9	<p>Remove the ACI/C card with its SRC ACT lamp lit.</p> <p>Requirement: The SRC ACT lamp on the original ACI/C card lights.</p>
10	<p>Reinsert the removed ACI/C card.</p> <p>Requirement: The SRC ACT lamp remains lit on the other ACI/C card.</p>
11	<p>Press the XFR pushbutton on either ACI/C card.</p> <p>Requirement: The lit SRC ACT lamp transfers to the other ACI/C card.</p>
12	<p>If the shelf is not to be equipped with two TNC-E/C clock cards or one TNC-E/C clock card and one TNC/C or LNC/C card clock card, skip this step. Set the TNCE/TNC switch (SW1) on the CEP to the TNCE position (Figure 3).</p> <p>Note: If the shelf is to be equipped with TNC/C or LNC/C card clock cards, leave SW1 in the TNC position.</p> <p>Requirement: If two ACI/C cards are installed, the SRC ACT lamps on both ACI/C cards are lit. The transfer (XFR) function between the ACI/C cards is disabled.</p>
13	<p>Indicate completion of the ACI/C Card Test on the Test Sign-off form.</p>

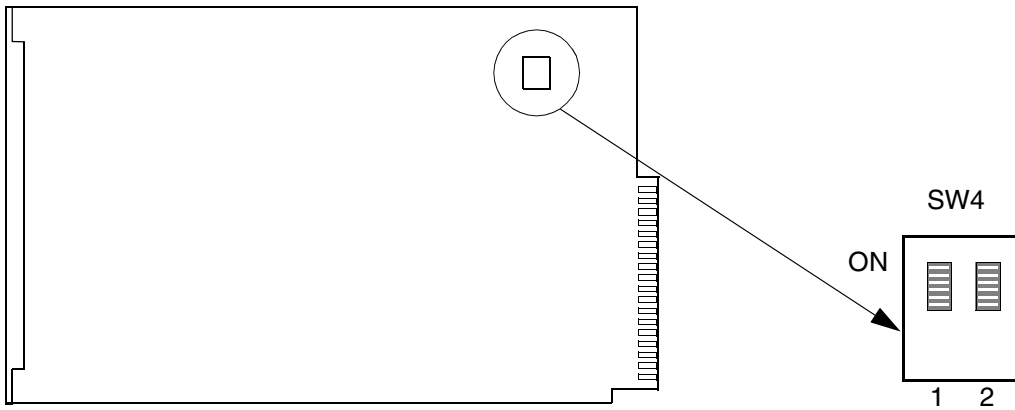

Note: All switches are shown in the factory-set position.

SW4 Settings

Section		Input Frequency	Factory Setting
1	2		
OFF	OFF	1 MHz	—
OFF	ON	2 MHz (2.048 MHz)	—
ON	OFF	5 MHz	—
ON	ON	10 MHz	X

Figure 8. ACI/C Card Switch

Chart 7. CI-EA/C Card Test

STEP	PROCEDURE
	<p>Use this procedure to install CI-EA/C cards. This procedure assumes the input reference signals have been connected per the Installation section of this manual. Consult the local company Installation Job Specifications to determine the type of input card to be installed in the MRA and MRB slots in the shelf.</p> <p>Note: If installing a CI-EA/C card in a remote system, contact your local Symmetricom distributor or Symmetricom's CTAC.</p> <p>Test Equipment: None</p>
1	<p>On the master shelf CEP, set the TNCE/TNC switch (Figure 3) to the TNC position for this test, regardless of the type of clock card to be installed.</p>
2	<p>Set switches SW1 and SW3 (Figure 9) on each CI-EA/C card to conform to the requirements for this installation.</p>
3	<p>Insert a CI-EA/C card into the MR A slot.</p> <p>Requirement: On the CI-EA/C card just installed, the E1 lamp is lit green, and the FAIL lamp goes off after approximately 8 seconds to 40 seconds. After the card has warmed up, the SRC ACTIVE lamp lights green.</p>
4	<p>If not equipped with a second CI-EA/C card, skip to Step 12. Insert the second CI-EA/C card into the MR B slot in the master shelf.</p> <p>Requirement: On the CI-EA/C card just installed, the E1 lamp is lit green, and the FAIL lamp goes off after approximately 8 seconds to 40 seconds. The SRC ACTIVE lamp remains off.</p>
5	<p>Press the XFR pushbutton on one of the CI-EA/C cards.</p> <p>Requirement: The lit SRC ACT lamp transfers to the other CI-EA/C card.</p>
6	<p>Press the XFR pushbutton on the other CI-EA/C card.</p> <p>Requirement: The lit SRC ACT lamp lights on the original CI-EA/C card.</p>
7	<p>Remove the CI-EA/C card with its SRC ACT lamp lit.</p> <p>Requirement: The SRC ACT lamp lights on the other CI-EA/C card.</p>
8	<p>Reinsert the removed CI-EA/C card.</p> <p>Requirement: The SRC ACT lamp remains lit on the other CI-EA/C card.</p>
9	<p>Remove the CI-EA/C card with its SRC ACT lamp lit.</p> <p>Requirement: The SRC ACT lamp on the original CI-EA/C card lights.</p>
10	<p>Reinsert the removed CI-EA/C card.</p> <p>Requirement: The SRC ACT lamp remains lit on the other CI-EA/C card.</p>

Chart 7. CI-EA/C Card Test (Contd)

STEP	PROCEDURE
11	<p>Press the XFR pushbutton on either CI-EA/C card.</p> <p>Requirement: The lit SRC ACT lamp transfers to the other CI-EA/C card.</p>
12	<p>If the shelf is not to be equipped with two TNC-E/C clock cards or one TNC-E/C clock card and one TNC/C or LNC/C card clock card, skip this step. Set the TNCE/TNC switch (SW1) on the CEP to the TNCE position (Figure 3).</p> <p>Note: If the shelf is to be equipped with TNC/C or LNC/C card clock cards, leave SW1 in the TNC position.</p> <p>Requirement: If two CI-EA/C cards are installed, the SRC ACT lamps on both CI-EA/C cards are lit. The transfer (XFR) function between the CI-EA/C cards is disabled.</p>
13	<p>Use the INIT-REG command for every MRC/C card in the shelf. This initializes all registers on the shelf.</p> <p>Requirement: The response indicates the command was completed successfully.</p>
14	<p>Indicate completion of the CI-EA/C Card Test on the Test Sign-off form.</p>

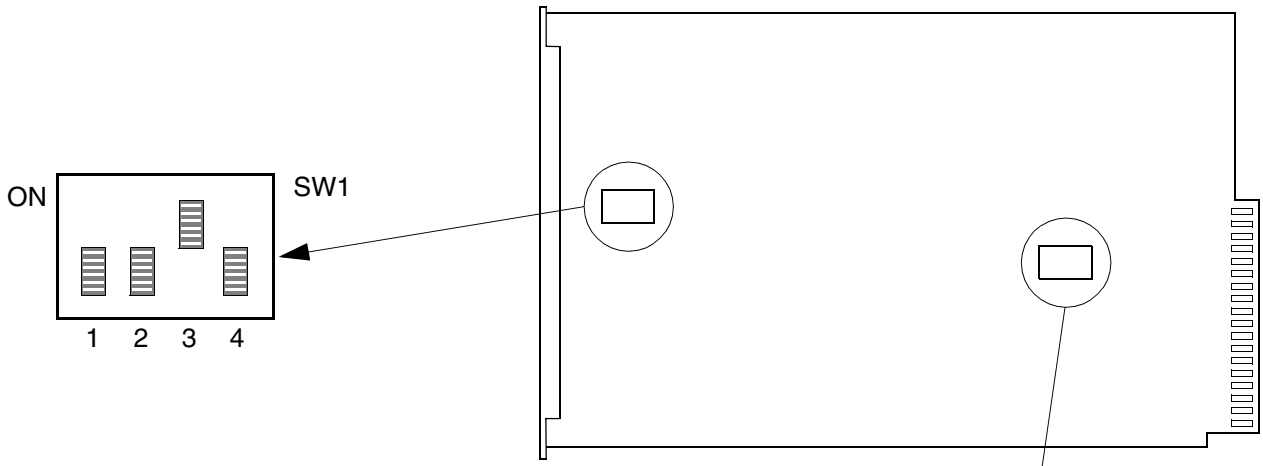

Note: All switches are shown in the factory-set position.

SW1 Settings

Section	Position	Meaning	Factory Setting
1 and 2	Up	Not allowed	—
	Down	Normal	X
3	Up	CRC4 is disabled	X
	Down	CRC4 is enabled	—
4	Up	CAS is disabled	—
	Down	CCS is enabled	X

SW3 Settings

Position	Meaning	Factory Setting
Up	E1 input (2.048 Mb/s)	X
Down	Analog input (2.048 MHz)	—
NOTE: All sections must be set to the same position.		

Figure 9. CI-EA/C Card Switch

Chart 8. CI/C Card Test

STEP	PROCEDURE
	<p>Use this procedure to install CI/C cards. This procedure assumes the input reference signals have been connected per the Installation section of this manual. Consult the local company Installation Job Specifications to determine the type of input card to be installed in the MRA and MRB slots in the shelf.</p> <p>Note: If installing an CI/C card in a remote system, contact your local Symmetricom distributor or Symmetricom's CTAC.</p> <p>Test Equipment: None</p>
1	On the master shelf CEP, set the TNCE/TNC switch (Figure 3) to the TNC position for this test, regardless of the type of clock card to be installed.
2	Set switch SW1 (Figure 10) on the CI/C card to conform to the requirements for this installation.
3	If not equipped with a second CI/C card, skip to the next step. Repeat the previous step for the second CI/C card.
4	<p>Insert a CI/C card into the MRA slot.</p> <p>Requirement: On the CI/C card just installed, the DS1 or CC lamp is lit green, and the FAIL lamp goes off after approximately 8 seconds to 40 seconds. After the card has warmed up, the SRC ACTIVE lamp lights green.</p>
5	<p>If the MRB slot is not equipped with a CI/C card, skip to the next step. Insert a CI/C card into the MRB slot.</p> <p>Requirement: On the CI/C card just installed, the DS1 or CC lamp is lit green, and the FAIL lamp goes off after approximately 8 seconds to 40 seconds. The SRC ACTIVE lamp remains off.</p>
6	<p>Press the XFR pushbutton on one of the CI/C cards.</p> <p>Requirement: The lit SRC ACT lamp transfers to the other CI/C card.</p>
7	<p>Press the XFR pushbutton on the other CI/C card.</p> <p>Requirement: The lit SRC ACT lamp lights on the original CI/C card.</p>
8	<p>Remove the CI/C card with its SRC ACT lamp lit.</p> <p>Requirement: The SRC ACT lamp lights on the other CI/C card.</p>
9	<p>Reinsert the removed CI/C card.</p> <p>Requirement: The SRC ACT lamp remains lit on the other CI/C card.</p>

Chart 8. CI/C Card Test (Contd)

STEP	PROCEDURE
10	<p>Remove the CI/C card with its SRC ACT lamp lit.</p> <p>Requirement: The SRC ACT lamp on the original CI/C card lights.</p>
11	<p>Reinsert the removed CI/C card.</p> <p>Requirement: The SRC ACT lamp remains lit on the other CI/C card.</p>
12	<p>Press the XFR pushbutton on either CI/C card.</p> <p>Requirement: The lit SRC ACT lamp transfers to the other CI/C card.</p>
13	<p>If the shelf is not to be equipped with two TNC-E/C clock cards or one TNC-E/C clock card and one TNC/C or LNC/C card clock card, skip this step. Set the TNCE/TNC switch (SW1) on the CEP to the TNCE position (Figure 3).</p> <p>Note: If the shelf is to be equipped with TNC/C or LNC/C card clock cards, leave SW1 in the TNC position.</p> <p>Requirement: If two CI/C cards are installed, the SRC ACT lamps on both CI/C cards are lit. The transfer (XFR) function between the CI/C cards is disabled.</p>
14	<p>Use the INIT-REG command for every MRC/C card in the shelf. This initializes all registers on the shelf.</p> <p>Requirement: The response indicates the command was completed successfully.</p>
15	<p>Indicate completion of the CI/C Card Test on the Test Sign-off form.</p>

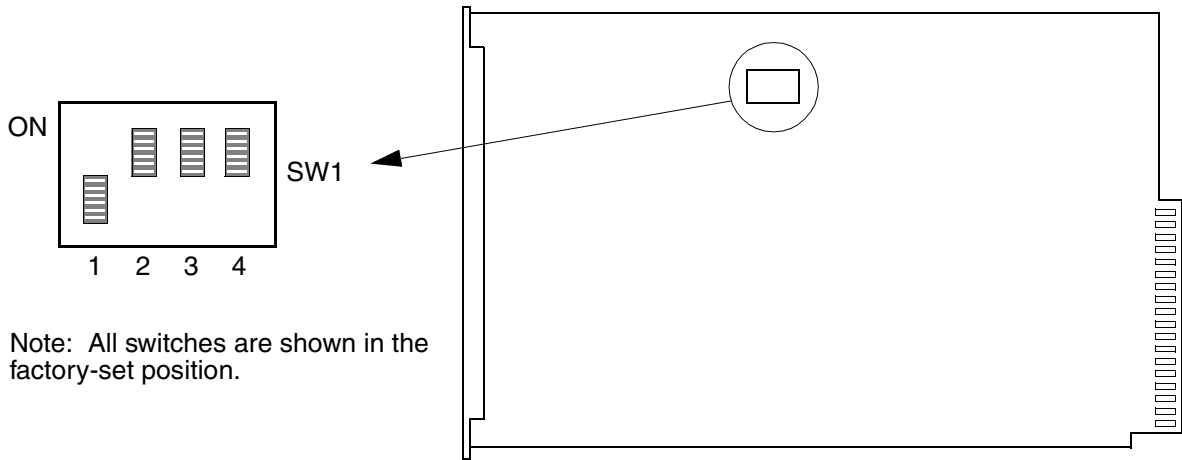

SW1 Settings

Section	Position	Meaning	Factory Setting
1	ON	T1 is not the input reference	—
	OFF	T1 is the input reference	X
2	ON	CC is not the reference	X
	OFF	CC is the reference	—
3	ON	D4 framing	X
	OFF	ESF framing	—
4	ON	No bipolar 8-zero substitution	X
	OFF	Bipolar 8-zero substitution	—

Figure 10. CI/C Card Switch

Chart 9. DCIM-EA/C Card Test

STEP	PROCEDURE
	<p>Use this procedure to verify the operation of the DCIM-EA/C card. This procedure assumes the input reference signals have been connected per the Installation section of this manual. Consult the local company Installation Job Specifications to determine the type of input card to be installed in the MRA and MRB slots in the shelf.</p> <p>Note: If installing a DCIM-EA/C card in a remote system, contact your local Symmetricom distributor or Symmetricom's CTAC.</p> <p>Test Equipment: None</p>
1	On the master shelf CEP, set the TNCE/TNC switch (Figure 3) to the TNC position for this test, regardless of the type of clock card to be installed.
2	Set switch SW2 (Figure 11) on each DCIM-EA/C card to conform to the requirements for this installation.
3	<p>Insert the first DCIM-EA/C card into the MR A slot.</p> <p>Requirement: On the DCIM-EA/C card just installed, the REF 1, REF 2, STATUS 1, and STATUS 2 lamps are lit green, and the FAIL lamp goes off after approximately 1 minute. After the card has warmed up, the SRC ACTIVE lamp lights green.</p>
4	<p>If not equipped with a second DCIM-EA/C card, skip to Step 14. Insert the second DCIM-EA/C card into the MR B slot in the master shelf.</p> <p>Requirement: On the DCIM-EA/C card just installed, the REF 1, REF 2, STATUS 1, and STATUS 2 lamps are lit green, and the FAIL lamp goes off after approximately 1 minute. After the card has warmed up, the SRC ACTIVE lamp lights green.</p>
5	<p>Press the XFR pushbutton on one of the DCIM-EA/C cards.</p> <p>Requirement: The lit SRC ACTIVE lamp transfers to the other DCIM-EA/C card.</p>
6	<p>Press the XFR pushbutton on the other DCIM-EA/C card.</p> <p>Requirement: The lit SRC ACTIVE lamp lights on the original DCIM-EA/C card.</p>
7	<p>Remove the DCIM-EA/C card with its SRC ACTIVE lamp lit.</p> <p>Requirement: The SRC ACTIVE lamp lights on the other DCIM-EA/C card.</p>
8	<p>Reinsert the removed DCIM-EA/C card.</p> <p>Requirement: The SRC ACTIVE lamp remains lit on the other DCIM-EA/C card.</p>
9	<p>Remove the DCIM-EA/C card with its SRC ACTIVE lamp lit.</p> <p>Requirement: The SRC ACTIVE lamp on the original DCIM-EA/C card lights.</p>

Chart 9. DCIM-EA/C Card Test (Contd)

STEP	PROCEDURE
10	Reinsert the removed DCIM-EA/C card. Requirement: The SRC ACTIVE lamp remains lit on the other DCIM-EA/C card.
11	Press the XFR pushbutton on either DCIM-EA/C card. Requirement: The lit SRC ACTIVE lamp transfers to the other DCIM-EA/C card.
12	Set the TNCE/TNC switch (SW1) on the CEP to conform to the requirements for this installation. Requirement: If SW1 is set to the TNCE position, the SRC ACTIVE lamps on both DCIM-EA/C cards are lit. The transfer (XFR) function between the DCIM-EA/C cards is disabled.
13	Use the INIT-REG command for every MRC/C card in the shelf. This initializes all registers on the shelf. Requirement: The response indicates the command was completed successfully.
14	Indicate completion of the DCIM-EA/C Card Test on the Test Sign-off form.

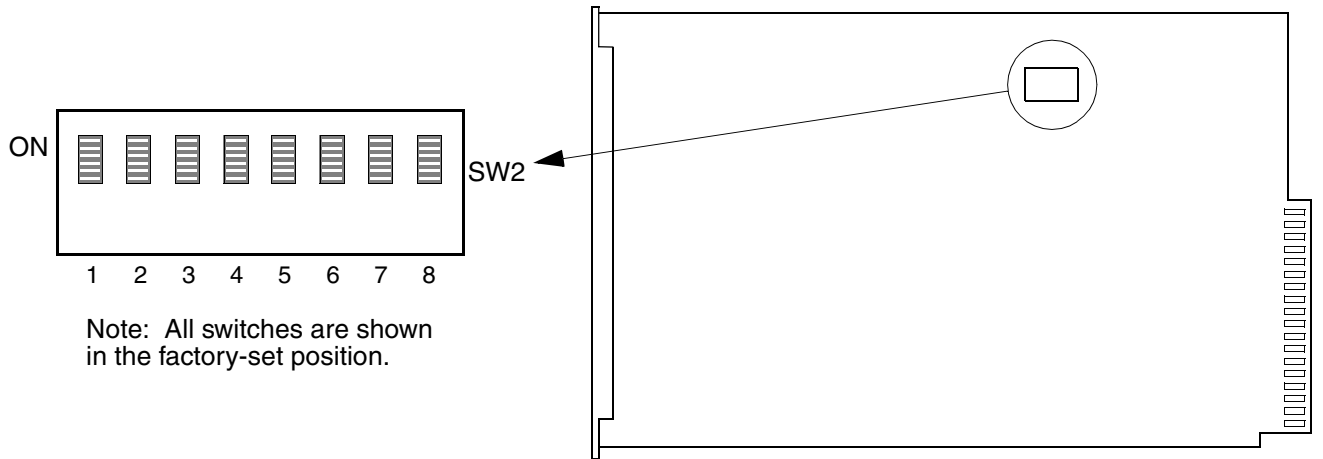

SW2 Settings

Section	Position	Meaning	Factory Setting
1	ON	Input Reference 1 Enabled	X
	OFF	Input Reference 1 Disabled	—
2	ON	Input Reference 2 Enabled	X
	OFF	Input Reference 2 Disabled	—
3	ON	Input Reference 1 Digital E1	X
	OFF	Input Reference 1 Analog	—
4	ON	Input Reference 2 Digital E1	X
	OFF	Input Reference 2 Analog	—
5	ON	Input Reference 1 Framing CCS	X
	OFF	Input Reference 1 Framing CAS	—
6	ON	Input Reference 1 Framing without CRC4	X
	OFF	Input Reference 1 Framing with CRC4	—
7	ON	Input Reference 2 Framing CCS	X
	OFF	Input Reference 2 Framing CAS	—
8	ON	Input Reference 2 Framing without CRC4	X
	OFF	Input Reference 2 Framing with CRC4	—

Figure 11. DCIM-EA/C Card Switch

Chart 10. TNC-E/C Card Test

STEP	PROCEDURE
	<p>Use this procedure to install two TNC-E/C cards in the same shelf. If the installation requires one TNC-E/C card and one TNC/C or LNC/C card, use the procedure in Chart 12.</p> <p>This procedure assumes the procedure for the clock input cards has been completed and input reference signals are connected to the inputs.</p> <p>Notes:</p> <ol style="list-style-type: none"> 1. The times indicated in the procedure are from the time the card is powered (inserted in the shelf). 2. If the FAIL lamp lights on an TNC-E/C card at any time, the card has failed and must be replaced. 3. There are no RTN pins specific to the LOCK, HOLDOVER, and FREERUN pins; when testing these pins, use the BATTRTN pin for RTN. 4. Resistance cannot be measured across certain test points if E2A telemetry equipment is connected to the test points or if an MIS/C card is installed in the shelf. <p>Test Equipment: Digital volt/ohm meter</p>
1	<p>On the master shelf CEP, set the TNCE/TNC switch (SW1) to the TNCE position (Figure 3).</p> <p>Requirement: Both clock input cards' SRC ACT or SRC ACTIVE lamps are lit.</p>
2	<p>On the TNC-E/C cards, set all sections of SW1 to the OFF (down) position (Figure 12).</p>
3	<p>In the master shelf, insert the first TNC-E/C card into the TNC A slot.</p> <p>Requirement: The HOLDOVER lamp flashes green during the approximately 60 minute stabilization period.</p>
4	<p>In the master shelf, insert the second TNC-E/C card into the TNC B slot.</p> <p>Note: No waiting period is necessary between inserting the first TNC-E/C card and the second TNC-E/C card.</p> <p>Requirement: The HOLDOVER lamp flashes green during the approximately 60 minute stabilization period.</p>
5	<p>After the 60 minute stabilization period, observe the HOLDOVER, SRC A, and SRC B lamps.</p> <p>Requirement: On both TNC-E/C cards, the HOLDOVER lamp goes off, and the SRC A lamp on the TNC-E/C A card and the SRC B lamp on the TNC-E/C B card both light green.</p> <p>Note: If a TNC-E/C does not recognize its associated SRC input (TNC-E/C A should recognize SRC A, TNC-E/C B should recognize SRC B), both TNC-E/C cards will look at the remaining available input and light their appropriate SRC lamps. If no inputs are available from either input card, the HOLDOVER lamp lights red and the ACTIVE lamp lights green to indicate the TNC-E/C cards are in freerun mode.</p>

Chart 10. TNC-E/C Card Test (Contd)

STEP	PROCEDURE																																			
6	<p>Before the ACTIVE lamps light on either TNC-E card, remove both clock input cards.</p> <p>Requirements: The SRC lamps on the TNC-E cards extinguish and the HOLDOVER lamps light steady green; the ACTIVE lamps light on both TNC-E cards to indicate they are in freerun mode.</p>																																			
7	<p>Connect the multimeter, set to the volts dc scale (if an MIS/C card is installed), or set to the resistance scale (if an SAI/C card is installed), across the following Office Alarm pins and Shelf Status pins of J5 on the CEP (Figure 3):</p> <table border="1" data-bbox="319 672 1468 873"> <thead> <tr> <th>Type</th> <th>Test Point</th> <th>Pin#</th> <th>Test Point</th> <th>Pin#</th> <th>Result MIS/C</th> <th>Result SAI/C</th> </tr> </thead> <tbody> <tr> <td>Shelf Status</td> <td>LOCK A</td> <td>27</td> <td>BATTRTN</td> <td>38</td> <td><0.1 V dc</td> <td><10 Ω</td> </tr> <tr> <td>Shelf Status</td> <td>FREE RUN A</td> <td>29</td> <td>BATTRTN</td> <td>38</td> <td><0.1 V dc</td> <td><10 Ω</td> </tr> <tr> <td>Shelf Status</td> <td>LOCK B</td> <td>2</td> <td>BATTRTN</td> <td>38</td> <td><0.1 V dc</td> <td><10 Ω</td> </tr> <tr> <td>Shelf Status</td> <td>FREE RUN B</td> <td>4</td> <td>BATTRTN</td> <td>38</td> <td><0.1 V dc</td> <td><10 Ω</td> </tr> </tbody> </table> <p>Requirement: The multimeter indicates the readings shown in the Result MIS/C or Result SAI/C column, depending on whether an MIS/C or SAI/C card is installed in the shelf.</p>	Type	Test Point	Pin#	Test Point	Pin#	Result MIS/C	Result SAI/C	Shelf Status	LOCK A	27	BATTRTN	38	<0.1 V dc	<10 Ω	Shelf Status	FREE RUN A	29	BATTRTN	38	<0.1 V dc	<10 Ω	Shelf Status	LOCK B	2	BATTRTN	38	<0.1 V dc	<10 Ω	Shelf Status	FREE RUN B	4	BATTRTN	38	<0.1 V dc	<10 Ω
Type	Test Point	Pin#	Test Point	Pin#	Result MIS/C	Result SAI/C																														
Shelf Status	LOCK A	27	BATTRTN	38	<0.1 V dc	<10 Ω																														
Shelf Status	FREE RUN A	29	BATTRTN	38	<0.1 V dc	<10 Ω																														
Shelf Status	LOCK B	2	BATTRTN	38	<0.1 V dc	<10 Ω																														
Shelf Status	FREE RUN B	4	BATTRTN	38	<0.1 V dc	<10 Ω																														
8	<p>Reinsert both clock input cards.</p> <p>Requirements: On the clock input cards, after the input source is acquired (approximately 8 seconds to 40 seconds for the ACI/C card, 1 minute for the DCIM-EA/C card, or 3 minutes to 5 minutes for the MRC/C card), the SRC ACT (ACI/C) or SRC ACTIVE (MRC/C or DCIM-EA/C) lamps light. The appropriate SRC lamps light, the HOLDOVER lamps go off, and the ACTIVE lamp remains lit on both TNC-E/C cards.</p>																																			
9	<p>Connect the multimeter, set to the volts dc scale (if an MIS/C card is installed), or set to the resistance scale (if an SAI/C card is installed), across the following Office Alarm pins and Shelf Status pins of J5 on the CEP (Figure 3):</p> <table border="1" data-bbox="319 1344 1468 1489"> <thead> <tr> <th>Type</th> <th>Test Point</th> <th>Pin#</th> <th>Test Point</th> <th>Pin#</th> <th>Result MIS/C</th> <th>Result SAI/C</th> </tr> </thead> <tbody> <tr> <td>Shelf Status</td> <td>FREE RUN A</td> <td>29</td> <td>BATTRTN</td> <td>38</td> <td>-42 V dc to -56 V dc</td> <td>>1 MΩ</td> </tr> <tr> <td>Shelf Status</td> <td>FREE RUN B</td> <td>4</td> <td>BATTRTN</td> <td>38</td> <td>-42 V dc to -56 V dc</td> <td>>1 MΩ</td> </tr> </tbody> </table> <p>Requirement: The multimeter indicates the readings shown in the Result MIS/C or Result SAI/C column, depending on whether an MIS/C or SAI/C card is installed in the shelf.</p>	Type	Test Point	Pin#	Test Point	Pin#	Result MIS/C	Result SAI/C	Shelf Status	FREE RUN A	29	BATTRTN	38	-42 V dc to -56 V dc	>1 MΩ	Shelf Status	FREE RUN B	4	BATTRTN	38	-42 V dc to -56 V dc	>1 MΩ														
Type	Test Point	Pin#	Test Point	Pin#	Result MIS/C	Result SAI/C																														
Shelf Status	FREE RUN A	29	BATTRTN	38	-42 V dc to -56 V dc	>1 MΩ																														
Shelf Status	FREE RUN B	4	BATTRTN	38	-42 V dc to -56 V dc	>1 MΩ																														
10	<p>In 8 seconds to 40 seconds for the ACI/C card, 1 minute for the DCIM-EA/C card, or 3 minutes to 5 minutes for the MRC/C card, observe the LKD lamps on the TNC-E/C cards.</p> <p>Requirement: On both TNC-E/C cards, the LKD lamps light green.</p> <p>Note: This indicates that the TNC-E/C cards are frequency locked with their input sources.</p>																																			

Chart 10. TNC-E/C Card Test (Contd)

STEP	PROCEDURE																					
11	<p>Connect the multimeter, set to the volts dc scale (if an MIS/C card is installed), or set to the resistance scale (if an SAI/C card is installed), across the following Office Alarm pins and Shelf Status pins of J5 on the CEP (Figure 3):</p> <table border="1" data-bbox="268 495 1393 622"> <thead> <tr> <th>Type</th> <th>Test Point</th> <th>Pin#</th> <th>Test Point</th> <th>Pin#</th> <th>Result MIS/C</th> <th>Result SAI/C</th> </tr> </thead> <tbody> <tr> <td>Shelf Status</td> <td>LOCK A</td> <td>27</td> <td>BATTRTN</td> <td>38</td> <td>-42 V dc to -56 V dc</td> <td>>1 MΩ</td> </tr> <tr> <td>Shelf Status</td> <td>LOCK B</td> <td>2</td> <td>BATTRTN</td> <td>38</td> <td>-42 V dc to -56 V dc</td> <td>>1 MΩ</td> </tr> </tbody> </table> <p>Requirement: The multimeter indicates the readings shown in the Result MIS/C or Result SAI/C column, depending on whether an MIS/C or SAI/C card is installed in the shelf.</p>	Type	Test Point	Pin#	Test Point	Pin#	Result MIS/C	Result SAI/C	Shelf Status	LOCK A	27	BATTRTN	38	-42 V dc to -56 V dc	>1 MΩ	Shelf Status	LOCK B	2	BATTRTN	38	-42 V dc to -56 V dc	>1 MΩ
Type	Test Point	Pin#	Test Point	Pin#	Result MIS/C	Result SAI/C																
Shelf Status	LOCK A	27	BATTRTN	38	-42 V dc to -56 V dc	>1 MΩ																
Shelf Status	LOCK B	2	BATTRTN	38	-42 V dc to -56 V dc	>1 MΩ																
12	<p>Remove the clock input A card.</p> <p>Requirements: The ACTIVE lamp on the TNC-E/C A card remains lit, the lit SRC A lamp goes off, and the SRC B lamp lights to indicate that the card is now receiving clocking from the clock input B card. The LKD lamp may go off, if so, it will relight after approximately 5 minutes.</p>																					
13	<p>Reinsert the clock input A card.</p> <p>Requirements: After the input source is acquired (approximately 8 seconds to 40 seconds for the ACI/C card, 1 minute for the DCIM-EA/C card, or 3 minutes to 5 minutes for the MRC/C card), the SRC ACT (ACI/C) or SRC ACTIVE (MRC/C or DCIM-EA/C) lamp lights on the input A card, the SRC A lamp lights, and the SRC B lamp goes off on the TNC-E/C A card. The LKD lamp may go off, if so, it will relight after approximately 5 minutes.</p>																					
14	<p>Remove the clock input B card.</p> <p>Requirement: The ACTIVE lamp on the TNC-E/C B card remains lit, the lit SRC B lamp goes off, and the SRC A lamp lights to indicate that the card is now receiving clocking from the clock input A card. The LKD lamp may go off, if so, it will relight after approximately 5 minutes.</p>																					
15	<p>Reinsert the clock input B card.</p> <p>Requirement: After the input source is acquired, the SRC ACT (ACI/C) or SRC ACTIVE (MRC/C or DCIM-EA/C) lamp lights on the clock input B card, the SRC B lamp lights, and the SRC A lamp goes off on the TNC-E/C B card. The LKD lamp may go off, if so, it will relight after approximately 5 minutes.</p>																					
16	<p>Remove both clock input cards.</p> <p>Requirement: On both TNC-E/C cards, the SRC and LKD lamps extinguish, the ACTIVE lamps remain lit, and the HOLDOVER lamps light red to indicate they are in holdover mode.</p>																					

Chart 10. TNC-E/C Card Test (Contd)

STEP	PROCEDURE																					
17	<p>Connect the multimeter, set to the volts dc scale (if an MIS/C card is installed), or set to the resistance scale (if an SAI/C card is installed), across the following Office Alarm pins and Shelf Status pins of J5 on the CEP (Figure 3):</p> <table border="1" data-bbox="319 492 1460 627"> <thead> <tr> <th>Type</th> <th>Test Point</th> <th>Pin#</th> <th>Test Point</th> <th>Pin#</th> <th>Result MIS/C</th> <th>Result SAI/C</th> </tr> </thead> <tbody> <tr> <td>Shelf Status</td> <td>HLD OVER A</td> <td>28</td> <td>BATTRTN</td> <td>38</td> <td><0.1 V dc</td> <td><10 Ω</td> </tr> <tr> <td>Shelf Status</td> <td>HLD OVER B</td> <td>3</td> <td>BATTRTN</td> <td>38</td> <td><0.1 V dc</td> <td><10 Ω</td> </tr> </tbody> </table> <p>Requirement: The multimeter indicates the readings shown in the Result MIS/C or Result SAI/C column, depending on whether an MIS/C or SAI/C card is installed in the shelf.</p>	Type	Test Point	Pin#	Test Point	Pin#	Result MIS/C	Result SAI/C	Shelf Status	HLD OVER A	28	BATTRTN	38	<0.1 V dc	<10 Ω	Shelf Status	HLD OVER B	3	BATTRTN	38	<0.1 V dc	<10 Ω
Type	Test Point	Pin#	Test Point	Pin#	Result MIS/C	Result SAI/C																
Shelf Status	HLD OVER A	28	BATTRTN	38	<0.1 V dc	<10 Ω																
Shelf Status	HLD OVER B	3	BATTRTN	38	<0.1 V dc	<10 Ω																
18	<p>Reinsert both clock input cards.</p> <p>Requirement: The SRC ACT (ACI/C) or SRC ACTIVE (MRC/C or DCIM-EA/C) lamps light on the clock input cards, the HOLDOVER lamps on both TNC-E/C cards go off, SRC A on the TNC-E/C A and SRC B on the TNC-E/C B light; then the LKD lamp on the TNC-E/C cards light.</p>																					
19	<p>Connect the multimeter, set to the volts dc scale (if an MIS/C card is installed), or set to the resistance scale (if an SAI/C card is installed), across the following Office Alarm pins and Shelf Status pins of J5 on the CEP (Figure 3):</p> <table border="1" data-bbox="319 1052 1460 1187"> <thead> <tr> <th>Type</th> <th>Test Point</th> <th>Pin#</th> <th>Test Point</th> <th>Pin#</th> <th>Result MIS/C</th> <th>Result SAI/C</th> </tr> </thead> <tbody> <tr> <td>Shelf Status</td> <td>HLD OVER A</td> <td>28</td> <td>BATTRTN</td> <td>38</td> <td>-42 V dc to -56 V dc</td> <td>>1 MΩ</td> </tr> <tr> <td>Shelf Status</td> <td>HLD OVER A</td> <td>3</td> <td>BATTRTN</td> <td>38</td> <td>-42 V dc to -56 V dc</td> <td>>1 MΩ</td> </tr> </tbody> </table> <p>Requirement: The multimeter indicates the readings shown in the Result MIS/C or Result SAI/C column, depending on whether an MIS/C or SAI/C card is installed in the shelf.</p>	Type	Test Point	Pin#	Test Point	Pin#	Result MIS/C	Result SAI/C	Shelf Status	HLD OVER A	28	BATTRTN	38	-42 V dc to -56 V dc	>1 MΩ	Shelf Status	HLD OVER A	3	BATTRTN	38	-42 V dc to -56 V dc	>1 MΩ
Type	Test Point	Pin#	Test Point	Pin#	Result MIS/C	Result SAI/C																
Shelf Status	HLD OVER A	28	BATTRTN	38	-42 V dc to -56 V dc	>1 MΩ																
Shelf Status	HLD OVER A	3	BATTRTN	38	-42 V dc to -56 V dc	>1 MΩ																
20	<p>If an SAI/C card is installed in the shelf, skip this step. Use the INIT-REG command for every MRC/C card in the shelf. This initializes all registers on the shelf.</p> <p>Requirement: The response indicates the command was completed successfully.</p>																					
21	<p>This procedure is completed. Indicate completion of the TNC-E/C Card Test on the Test Sign-off form.</p>																					

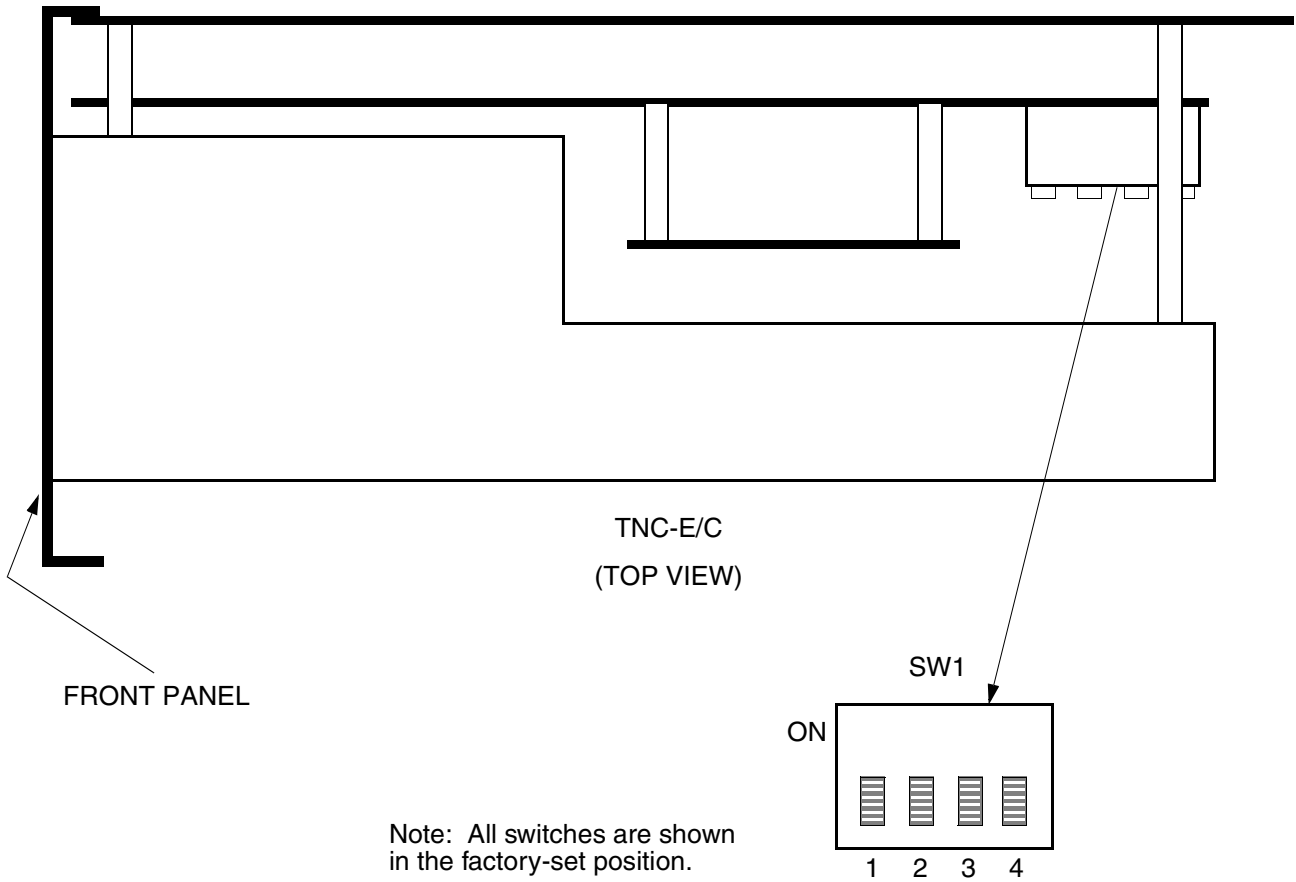

Switch SW1 Settings

Section	Position	Meaning	Factory Setting
2	ON	One TNC-E/C card installed in clock card slot A and one TNC/C or LNC/C card installed in clock card slot B (see Chart 12)	—
	OFF	Two TNC-E/C cards installed in shelf	X

Note: All other sections must be set to OFF (factory setting).

Figure 12. TNC-E/C Card Switch

Chart 11. TNC/C and LNC/C Card Test

STEP	PROCEDURE
	<p>Use this procedure to install two TNC/C or two LNC/C cards. If the installation is one TNC-E/C and one TNC/C or LNC/C card, use the procedure in Chart 12.</p> <p>Notes:</p> <ol style="list-style-type: none"> 1. There are no RTN pins specific to the LOCK, HOLDOVER, and FREERUN pins; when testing these pins, use the BATTRTN pin for RTN. 2. Resistance cannot be measured across certain test points if office alarm and remote telemetry equipment are connected to the test points or if an MIS/C card is installed in the shelf. <p>Test Equipment: Digital volt/ohm meter</p>
1	On the master shelf CEP, set the TNCE/TNC switch (SW1) to the TNC position, and be sure the MAJ and center pins on the PWR ALM jumper block (JP1) (Figure 3) are closed.
2	On the TNC/C or LNC/C cards, ensure that the switches are set as illustrated in Figure 13 for the TNC/C or Figure 14 for the LNC/C.
3	If a GTI/C -13 or -14 card is installed in the DCD-LPR/C, and the DCD-LPR/C is connected to a DCD System equipped with LNC/C cards, a thermal insulator must be installed on the LNC/C card's oven-controlled crystal oscillator (OCXO). Refer to the thermal insulator kit for installation instructions.
4	In the master shelf, insert the first TNC/C or LNC/C card into the TNC A slot.
5	In the master shelf, insert the second TNC/C or LNC/C card into the TNC B slot.
6	<p>During the 30 minute (approximately) oscillator stabilization period, observe the FREE RUN lamps on both TNC/C or LNC/C cards.</p> <p>Requirement: On both TNC/C or LNC/C cards, the FREE RUN lamps flash green.</p>
7	<p>After the 30 minute oscillator stabilization period, observe the FREE RUN, REF A, and REF B lamps.</p> <p>Requirement: On both TNC/C or LNC/C cards, the FREE RUN lamps stop flashing and go off. On both TNC/C or LNC/C cards, the REF A or B lamp lights, depending on which clock input (A or B) card's SRC ACT or SRC ACTIVE lamp is lit.</p> <p>Note: If a TNC/C or LNC/C card does not recognize an input reference signal, the TNC/C or LNC/C card free runs and the FREE RUN lamp lights green (not flashing).</p>
8	<p>Approximately 5 minutes (up to 20 minutes for worst-case signal conditions) after the end of the 30 minute oscillator stabilization period, observe the LOCKED and ACTIVE lamps on the TNC/C or LNC/C cards.</p> <p>Requirement: On both TNC/C or LNC/C cards, the LOCKED and ACTIVE lamps light green.</p>

Chart 11. TNC/C and LNC/C Card Test (Contd)

STEP	PROCEDURE
9	<p>Press the transfer (XFR) pushbutton on either clock input card. Observe the SRC ACT or SRC ACTIVE lamps on the clock input cards and the REF and LOCKED lamps on the TNC/C or LNC/C cards.</p> <p>Requirement: The SRC ACT or SRC ACTIVE lamp goes off on one clock input card and lights on the other. The lit REF lamp (REF A or REF B) goes off and the other REF lamp lights on both TNC/C or LNC/C cards. If the clock input cards are off frequency from each other, the LOCKED lamps on the TNC/C or LNC/C cards may go off while converging on the new reference and relight after approximately 5 minutes.</p>
10	<p>Press the transfer (XFR) pushbutton on either clock input card to transfer back to the original clock input card. Observe the SRC ACT or SRC ACTIVE lamps on the clock input cards and the REF and LOCKED lamps on the TNC/C or LNC/C cards.</p> <p>Requirement: The SRC ACT or SRC ACTIVE lamp goes off on one clock input card and lights on the other. The lit REF lamp (REF A or REF B) goes off and the other REF lamp lights on both TNC/C or LNC/C cards. If the clock input cards are off frequency from each other, the LOCKED lamps on the TNC/C or LNC/C cards may go off while converging on the new reference and relight after approximately 5 minutes.</p>
11	<p>If the clock input A card's SRC ACT or SRC ACTIVE lamp is off, press its XFR pushbutton to make it active. Remove the clock input A card. Observe the SRC ACT or SRC ACTIVE lamp on the clock input B card and the REF and LOCKED lamps on the TNC/C or LNC/C cards.</p> <p>Requirement: The SRC ACT or SRC ACTIVE lamp on the clock input B card lights. The REF A lamp goes off and the REF B lamps light on both TNC/C or LNC/C cards. The LOCKED lamp on one or both TNC/C or LNC/C cards may go off while converging on the new reference and relight after approximately 5 minutes.</p>
12	<p>Reinsert the clock input A card. When the FAIL lamp goes off on the clock input A card (after approximately 8 seconds to 40 seconds for CI-EA/C cards, 1 minute for DCIM-EA/C cards, or 3 minutes to 5 minutes for MRC/C cards), observe the REF lamps (A and B) on both TNC/C cards.</p> <p>Requirement: No change on the lamps.</p>
13	<p>Remove both clock input A and B cards. Observe the lamps on the MIS/C and both TNC/C or LNC/C cards.</p> <p>Requirement: On the MIS/C card, the MAJOR and MINOR lamps light. On both TNC/C or LNC/C cards, the REF and LOCKED lamps go off, the HOLD OV lamps light.</p>

Chart 11. TNC/C and LNC/C Card Test (Contd)

STEP	PROCEDURE																																																																																			
14	<p>Connect the multimeter, set to resistance or volts dc as indicated, across the following Office Alarm pins and Shelf Status pins of J5 on the CEP (Figure 3):</p> <table border="1" data-bbox="319 470 1503 896"> <thead> <tr> <th>Type</th> <th>Test Point</th> <th>Pin#</th> <th>Test Point</th> <th>Pin#</th> <th>Result MIS/C</th> <th>Result SAI/C</th> </tr> </thead> <tbody> <tr> <td>Office Alarm</td> <td>MAJ AUD NO</td> <td>42</td> <td>MAJ AUD C</td> <td>17</td> <td><10 Ω</td> <td><10 Ω</td> </tr> <tr> <td>Office Alarm</td> <td>MAJ VIS NO</td> <td>18</td> <td>MAJ VIS C</td> <td>44</td> <td><10 Ω</td> <td><10 Ω</td> </tr> <tr> <td>Office Alarm</td> <td>MIN AUD NO</td> <td>45</td> <td>MIN AUD C</td> <td>20</td> <td><10 Ω</td> <td><10 Ω</td> </tr> <tr> <td>Office Alarm</td> <td>MIN VIS NO</td> <td>21</td> <td>MIN VIS C</td> <td>47</td> <td><10 Ω</td> <td><10 Ω</td> </tr> <tr> <td>Shelf Status</td> <td>MAJSI</td> <td>12</td> <td>MAJSR</td> <td>37</td> <td><10 Ω</td> <td><10 Ω</td> </tr> <tr> <td>Shelf Status</td> <td>MINSI</td> <td>11</td> <td>MINSR</td> <td>36</td> <td><10 Ω</td> <td><10 Ω</td> </tr> <tr> <td>Clock Status A</td> <td>HOLDOVER A</td> <td>28</td> <td>BATTRTN</td> <td>38</td> <td><0.1 V dc</td> <td><0.1 V dc</td> </tr> <tr> <td>Clock Status A</td> <td>LOCK A</td> <td>27</td> <td>BATTRTN</td> <td>38</td> <td><0.1 V dc</td> <td><10 Ω</td> </tr> <tr> <td>Clock Status B</td> <td>HOLDOVER B</td> <td>3</td> <td>BATTRTN</td> <td>38</td> <td><0.1 V dc</td> <td><0.1 V dc</td> </tr> <tr> <td>Clock Status B</td> <td>LOCK B</td> <td>2</td> <td>BATTRTN</td> <td>38</td> <td><0.1 V dc</td> <td><10 Ω</td> </tr> </tbody> </table> <p>Requirement: The multimeter indicates the readings shown in the Result MIS/C or Result SAI/C column, depending on whether an MIS/C or SAI/C card is installed in the shelf.</p>							Type	Test Point	Pin#	Test Point	Pin#	Result MIS/C	Result SAI/C	Office Alarm	MAJ AUD NO	42	MAJ AUD C	17	<10 Ω	<10 Ω	Office Alarm	MAJ VIS NO	18	MAJ VIS C	44	<10 Ω	<10 Ω	Office Alarm	MIN AUD NO	45	MIN AUD C	20	<10 Ω	<10 Ω	Office Alarm	MIN VIS NO	21	MIN VIS C	47	<10 Ω	<10 Ω	Shelf Status	MAJSI	12	MAJSR	37	<10 Ω	<10 Ω	Shelf Status	MINSI	11	MINSR	36	<10 Ω	<10 Ω	Clock Status A	HOLDOVER A	28	BATTRTN	38	<0.1 V dc	<0.1 V dc	Clock Status A	LOCK A	27	BATTRTN	38	<0.1 V dc	<10 Ω	Clock Status B	HOLDOVER B	3	BATTRTN	38	<0.1 V dc	<0.1 V dc	Clock Status B	LOCK B	2	BATTRTN	38	<0.1 V dc	<10 Ω
Type	Test Point	Pin#	Test Point	Pin#	Result MIS/C	Result SAI/C																																																																														
Office Alarm	MAJ AUD NO	42	MAJ AUD C	17	<10 Ω	<10 Ω																																																																														
Office Alarm	MAJ VIS NO	18	MAJ VIS C	44	<10 Ω	<10 Ω																																																																														
Office Alarm	MIN AUD NO	45	MIN AUD C	20	<10 Ω	<10 Ω																																																																														
Office Alarm	MIN VIS NO	21	MIN VIS C	47	<10 Ω	<10 Ω																																																																														
Shelf Status	MAJSI	12	MAJSR	37	<10 Ω	<10 Ω																																																																														
Shelf Status	MINSI	11	MINSR	36	<10 Ω	<10 Ω																																																																														
Clock Status A	HOLDOVER A	28	BATTRTN	38	<0.1 V dc	<0.1 V dc																																																																														
Clock Status A	LOCK A	27	BATTRTN	38	<0.1 V dc	<10 Ω																																																																														
Clock Status B	HOLDOVER B	3	BATTRTN	38	<0.1 V dc	<0.1 V dc																																																																														
Clock Status B	LOCK B	2	BATTRTN	38	<0.1 V dc	<10 Ω																																																																														
15	<p>Reinsert both clock input cards. After the FAIL lamps go off (about 5 minutes), observe the lamps on the MIS/C and both TNC/C or LNC/C cards.</p> <p>Requirement: On both TNC/C or LNC/C cards, the REF A or B lamp is lit (depending on which clock input card's SRC ACT or SRC ACTIVE lamp is lit), the LOCKED and ACTIVE lamps are lit, and the HOLD OV lamp is off. The MAJOR and MINOR lamps on the MIS/C are off.</p>																																																																																			
16	<p>Connect the multimeter, set to resistance or volts dc as indicated, across the following Office Alarm pins and Shelf Status pins of J5 on the CEP (Figure 3):</p> <table border="1" data-bbox="319 1299 1503 1724"> <thead> <tr> <th>Type</th> <th>Test Point</th> <th>Pin#</th> <th>Test Point</th> <th>Pin#</th> <th>Result MIS/C</th> <th>Result SAI/C</th> </tr> </thead> <tbody> <tr> <td>Office Alarm</td> <td>MAJ AUD NO</td> <td>42</td> <td>MAJ AUD C</td> <td>17</td> <td>>1 MΩ</td> <td>>1 MΩ</td> </tr> <tr> <td>Office Alarm</td> <td>MAJ VIS NO</td> <td>18</td> <td>MAJ VIS C</td> <td>44</td> <td>>1 MΩ</td> <td>>1 MΩ</td> </tr> <tr> <td>Office Alarm</td> <td>MIN AUD NO</td> <td>45</td> <td>MIN AUD C</td> <td>20</td> <td>>1 MΩ</td> <td>>1 MΩ</td> </tr> <tr> <td>Office Alarm</td> <td>MIN VIS NO</td> <td>21</td> <td>MIN VIS C</td> <td>47</td> <td>>1 MΩ</td> <td>>1 MΩ</td> </tr> <tr> <td>Shelf Status</td> <td>MAJSI</td> <td>12</td> <td>MAJSR</td> <td>37</td> <td>>1 MΩ</td> <td>>1 MΩ</td> </tr> <tr> <td>Shelf Status</td> <td>MINSI</td> <td>11</td> <td>MINSR</td> <td>36</td> <td>>1 MΩ</td> <td>>1 MΩ</td> </tr> <tr> <td>Clock Status A</td> <td>HOLDOVER A</td> <td>28</td> <td>BATTRTN</td> <td>38</td> <td>-42 V dc to -56 V dc</td> <td>-42 V dc to -56 V dc</td> </tr> <tr> <td>Clock Status A</td> <td>LOCK A</td> <td>27</td> <td>BATTRTN</td> <td>38</td> <td>-42 V dc to -56 V dc</td> <td>>1 MΩ</td> </tr> <tr> <td>Clock Status B</td> <td>HOLDOVER B</td> <td>3</td> <td>BATTRTN</td> <td>38</td> <td>-42 V dc to -56 V dc</td> <td>-42 V dc to -56 V dc</td> </tr> <tr> <td>Clock Status B</td> <td>LOCK B</td> <td>2</td> <td>BATTRTN</td> <td>38</td> <td>-42 V dc to -56 V dc</td> <td>>1 MΩ</td> </tr> </tbody> </table> <p>Requirement: The multimeter indicates the readings shown in the Result MIS/C or Result SAI/C column, depending on whether an MIS/C or SAI/C card is installed in the shelf.</p>							Type	Test Point	Pin#	Test Point	Pin#	Result MIS/C	Result SAI/C	Office Alarm	MAJ AUD NO	42	MAJ AUD C	17	>1 MΩ	>1 MΩ	Office Alarm	MAJ VIS NO	18	MAJ VIS C	44	>1 MΩ	>1 MΩ	Office Alarm	MIN AUD NO	45	MIN AUD C	20	>1 MΩ	>1 MΩ	Office Alarm	MIN VIS NO	21	MIN VIS C	47	>1 MΩ	>1 MΩ	Shelf Status	MAJSI	12	MAJSR	37	>1 MΩ	>1 MΩ	Shelf Status	MINSI	11	MINSR	36	>1 MΩ	>1 MΩ	Clock Status A	HOLDOVER A	28	BATTRTN	38	-42 V dc to -56 V dc	-42 V dc to -56 V dc	Clock Status A	LOCK A	27	BATTRTN	38	-42 V dc to -56 V dc	>1 MΩ	Clock Status B	HOLDOVER B	3	BATTRTN	38	-42 V dc to -56 V dc	-42 V dc to -56 V dc	Clock Status B	LOCK B	2	BATTRTN	38	-42 V dc to -56 V dc	>1 MΩ
Type	Test Point	Pin#	Test Point	Pin#	Result MIS/C	Result SAI/C																																																																														
Office Alarm	MAJ AUD NO	42	MAJ AUD C	17	>1 MΩ	>1 MΩ																																																																														
Office Alarm	MAJ VIS NO	18	MAJ VIS C	44	>1 MΩ	>1 MΩ																																																																														
Office Alarm	MIN AUD NO	45	MIN AUD C	20	>1 MΩ	>1 MΩ																																																																														
Office Alarm	MIN VIS NO	21	MIN VIS C	47	>1 MΩ	>1 MΩ																																																																														
Shelf Status	MAJSI	12	MAJSR	37	>1 MΩ	>1 MΩ																																																																														
Shelf Status	MINSI	11	MINSR	36	>1 MΩ	>1 MΩ																																																																														
Clock Status A	HOLDOVER A	28	BATTRTN	38	-42 V dc to -56 V dc	-42 V dc to -56 V dc																																																																														
Clock Status A	LOCK A	27	BATTRTN	38	-42 V dc to -56 V dc	>1 MΩ																																																																														
Clock Status B	HOLDOVER B	3	BATTRTN	38	-42 V dc to -56 V dc	-42 V dc to -56 V dc																																																																														
Clock Status B	LOCK B	2	BATTRTN	38	-42 V dc to -56 V dc	>1 MΩ																																																																														

Chart 11. TNC/C and LNC/C Card Test (Contd)

STEP	PROCEDURE
17	On the master shelf CEP, close the MIN and center pins on the PWR ALM jumper block (JP1) (Figure 3).
18	Remove both clock input cards. Observe the lamps on the MIS/C and both TNC/C or LNC/C cards. Requirement: On the MIS/C card, the MINOR lamp lights. On both TNC/C or LNC/C cards, the REF and LOCKED lamps go off, the HOLD OV lamps light, and the ACTIVE lamps remain lit.
19	Reinsert both clock input cards. After the FAIL lamps go off (about 5 minutes), observe the lamps on the MIS/C and both TNC/C or LNC/C cards. Requirement: On both TNC/C or LNC/C cards, the REF A or B lamp is lit (depending on which clock input card's SRC ACT or SRC ACTIVE lamp is lit), the LOCKED and ACTIVE lamps are lit, and the HOLD OV lamp is off. The MINOR lamp on the MIS/C card is off.
20	If the Holdover mode is to generate a minor alarm for this system, skip this step. Close the MAJ and center pins on the PWR ALM jumper block (JP1) on the CEP (Figure 3).
21	If an SAI/C card is installed in the shelf, skip this step. Use the INIT-REG command for every MRC/C card in the shelf. This initializes all registers on the shelf. Requirement: The response indicates the command was completed successfully.
22	This procedure is completed. Indicate completion of the TNC/C and LNC/C card Test on the Test Sign-off form.

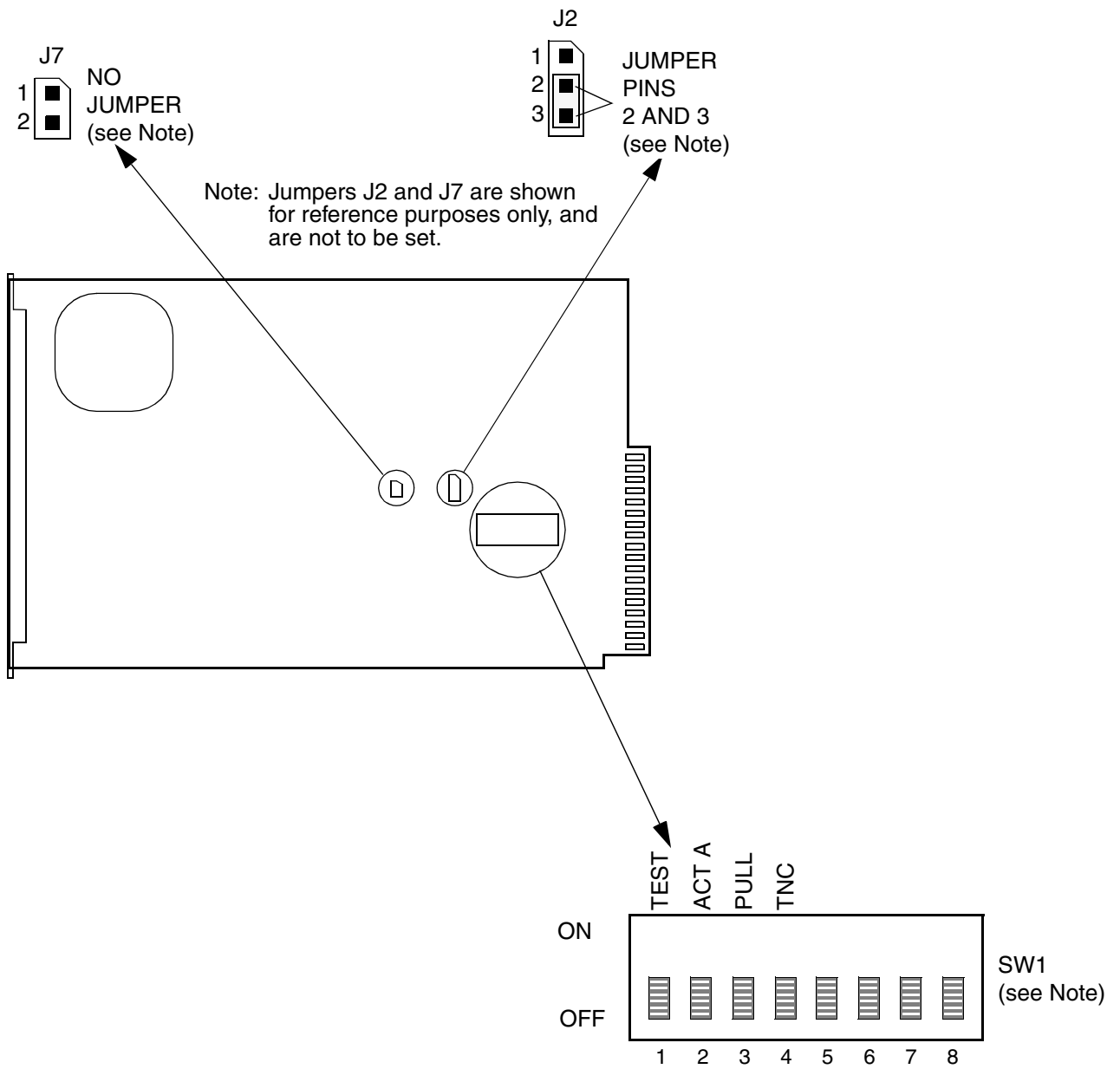
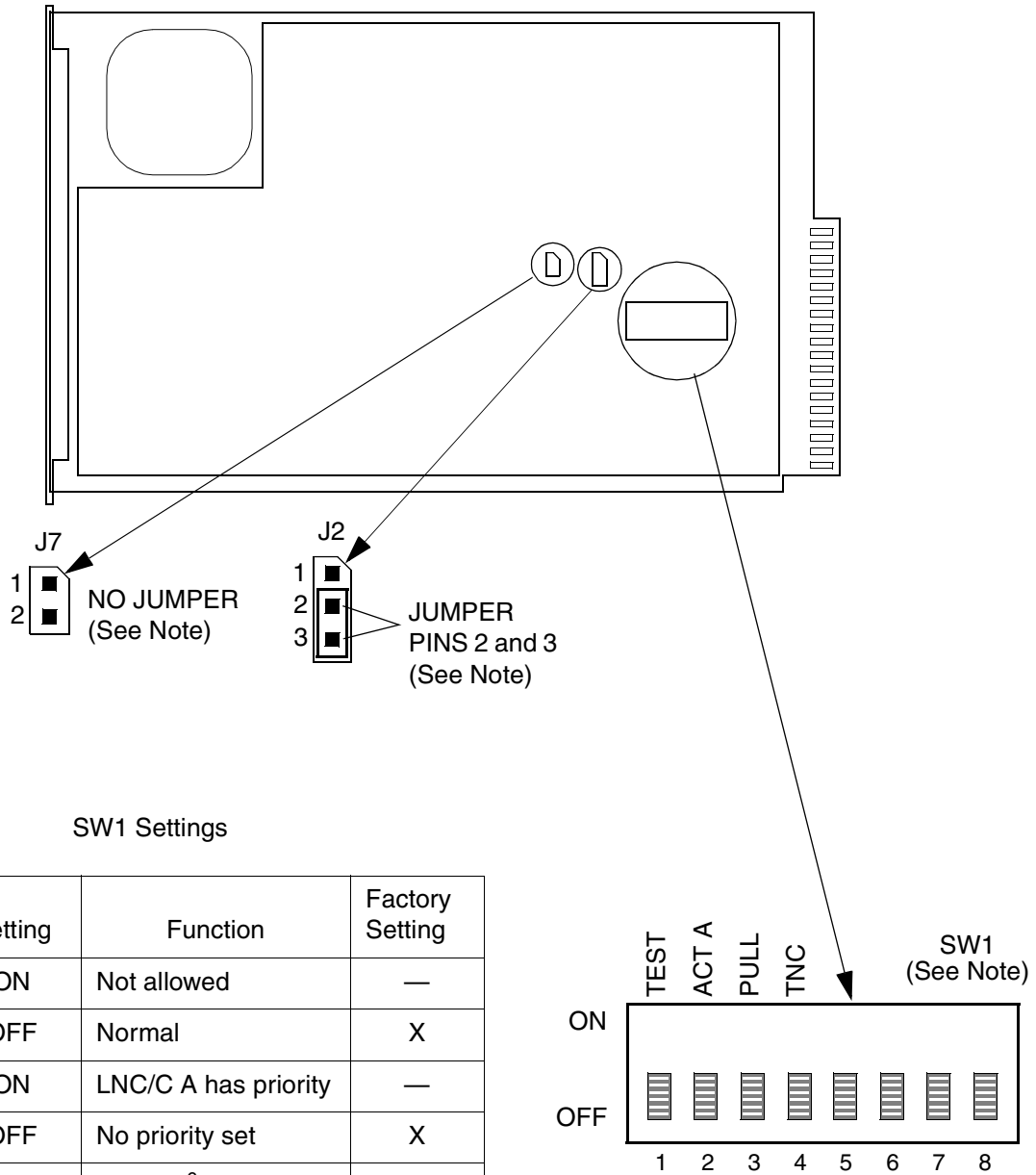

Figure 13. TNC/C Card Switch



SW1 Settings

Section	Setting	Function	Factory Setting
1	ON	Not allowed	—
	OFF	Normal	X
2	ON	LNC/C A has priority	—
	OFF	No priority set	X
3	ON	$\pm 2 \times 10^{-6}$ pull-in	—
	OFF	$\pm 5.6 \times 10^{-6}$ pull-in	X
4 to 8	ON	Not allowed	—
	OFF	Normal	X

Note: All switches and jumpers are shown in the factory-set position. Jumpers J2 and J7 are shown for reference purposes only, and are not to be set.

Figure 14. LNC/C Card Switch

Chart 12. TNC-E/C Card with TNC/C or LNC/C Card Test

STEP	PROCEDURE
	<p>Use this procedure to install one TNC-E/C and one TNC/C or LNC/C card (quartz clock card) in a DCD-521/C Shelf.</p> <p>Notes:</p> <ol style="list-style-type: none"> 1. There are no RTN pins specific to the LOCK, HOLDOVER, and FREERUN pins; when testing these pins, use the BATTRTN pin for RTN. 2. Resistance cannot be measured across certain test points if office alarm and remote telemetry equipment are connected to the test points or if an MIS/C card is installed in the shelf. 3. When Issue A of the TNC-E/C card is installed, use only the LPR/C as an input reference clock. Issue B of the TNC-E/C cannot be installed in the same shelf as a quartz clock card. Issue C or later of the TNC-E/C may use either the DCD-LPR/C or a network source as a reference input. Replace an Issue B of the TNC-E/C with Issue C or later TNC-E/C card. <p>Test Equipment: Digital volt/ohm meter</p>
1	<p>On the master shelf CEP, set the TNCE/TNC switch (SW1) to the TNC position, and close the MAJ and center pins on the PWR ALM jumper block (JP1) (Figure 3).</p>
2	<p>On the TNC-E/C card, set SW1, section 2 to the ON position and all other sections OFF (Figure 12).</p>
3	<p>In the master shelf, insert the TNC-E/C card into the TNC A slot.</p>
4	<p>During the 60 minute (approximately) oscillator stabilization period, observe the HOLDOVER lamp on the TNC-E/C.</p> <p>Requirement: The HOLDOVER lamp flashes green.</p>
5	<p>After the 60 minute oscillator stabilization period, observe the HOLDOVER, SRC A, and SRC B lamps.</p> <p>Requirement: The HOLDOVER lamp stops flashing and goes off, the SRC A or B lamp lights, depending on which clock input (A or B) card's SRC ACT or SRC ACTIVE lamp is lit.</p> <p>Note: If a TNC-E/C does not recognize an input reference signal, the TNC-E/C free runs and the HOLDOVER lamp lights green (not flashing).</p>
6	<p>Approximately 5 minutes (up to 20 minutes for worst-case signal conditions) after the end of the 30 minute oscillator stabilization period, observe the LOCKED and ACTIVE lamps on the TNC-E/C.</p> <p>Requirement: The LOCKED and ACTIVE lamps light green.</p>
7	<p>If a TNC/C card is to be installed, skip this step. If an LNC/C card is to be installed, check the LNC/C card's front panel for the "THERMAL INSULATOR INSTALLED" label; if the label is not there, go to the thermal insulator kit for instructions on installing the thermal insulator on the LNC/C card. If the label is there, or if the insulator has been installed, continue.</p>
8	<p>On the quartz clock card, ensure that the switches are set as illustrated in Figure 13 for the TNC/C or Figure 14 for the LNC/C.</p>

Chart 12. TNC-E/C Card with TNC/C or LNC/C Card Test

STEP	PROCEDURE
9	In the master shelf, insert the quartz clock card into the TNC B slot.
10	<p>During the 30 minute (approximately) oscillator stabilization period, observe the HOLDOVER and FREE RUN lamps on the quartz clock cards.</p> <p>Requirement: The HOLDOVER and FREE RUN lamps light red during holdover.</p>
11	<p>After the 30 minute oscillator stabilization period, observe the HOLDOVER, FREE RUN, REF A, and REF B lamps.</p> <p>Requirement: The HOLDOVER and FREE RUN lamps go off, the REF A or B lamp lights, depending on which clock input (A or B) card's SRC ACT or SRC ACTIVE lamp is lit.</p> <p>Note: If a TNC/C card does not recognize an input reference signal, the TNC/C free runs and the FREE RUN lamp lights green (not flashing).</p>
12	<p>Approximately 5 minutes (up to 20 minutes for worst-case signal conditions) after the end of the 30 minute oscillator stabilization period, observe the LOCKED and ACTIVE lamps on the quartz clock card.</p> <p>Requirement: The LOCKED and ACTIVE lamps light green.</p>
13	<p>Remove the clock input A card.</p> <p>Requirement: The SRC/REF A lamp goes off and the SRC/REF B lamps light on both clock cards. The LOCKED lamp on one or both clock cards may go off while converging on the new reference and relight after approximately 5 minutes.</p>
14	<p>Reinsert the clock input A card. When the FAIL lamp goes off on the clock input A card, observe the SRC/REF lamps (A and B) on both clock cards.</p> <p>Requirement: The SRC A lamp lights on the TNC-E/C indicating reference has reverted to SRC A; the REF B lamp is still lit on the quartz clock card indicating reference remains on SRC B.</p>
15	<p>Remove both clock input A and B cards.</p> <p>Requirement: On the MIS/C card, the MAJOR and MINOR lamps light. On both clock cards, the SRC/REF and LOCKED lamps go off, the HOLD OV lamps light, and the ACTIVE lamps remain lit.</p>

Chart 12. TNC-E/C Card with TNC/C or LNC/C Card Test

STEP	PROCEDURE																																																																													
16	<p>Connect the multimeter, set to resistance or volts dc as indicated, across the following Office Alarm pins and Shelf Status pins of J5 on the CEP (Figure 3):</p> <table border="1" data-bbox="319 470 1484 896"> <thead> <tr> <th>Type</th> <th>Test Point</th> <th>Pin#</th> <th>Test Point</th> <th>Pin#</th> <th>Result MIS/C</th> <th>Result SAI/C</th> </tr> </thead> <tbody> <tr> <td>Office Alarm</td> <td>MAJ AUD NO</td> <td>42</td> <td>MAJ AUD C</td> <td>17</td> <td><10 Ω</td> <td><10 Ω</td> </tr> <tr> <td>Office Alarm</td> <td>MAJ VIS NO</td> <td>18</td> <td>MAJ VIS C</td> <td>44</td> <td><10 Ω</td> <td><10 Ω</td> </tr> <tr> <td>Office Alarm</td> <td>MIN AUD NO</td> <td>45</td> <td>MIN AUD C</td> <td>20</td> <td><10 Ω</td> <td><10 Ω</td> </tr> <tr> <td>Office Alarm</td> <td>MIN VIS NO</td> <td>21</td> <td>MIN VIS C</td> <td>47</td> <td><10 Ω</td> <td><10 Ω</td> </tr> <tr> <td>Shelf Status</td> <td>MAJSI</td> <td>12</td> <td>MAJSR</td> <td>37</td> <td><10 Ω</td> <td><10 Ω</td> </tr> <tr> <td>Shelf Status</td> <td>MINSI</td> <td>11</td> <td>MINSR</td> <td>36</td> <td><10 Ω</td> <td><10 Ω</td> </tr> <tr> <td>Clock Status A</td> <td>HOLDOVER A</td> <td>28</td> <td>BATTRTN</td> <td>38</td> <td><0.1 V dc</td> <td><0.1 V dc</td> </tr> <tr> <td>Clock Status A</td> <td>LOCK A</td> <td>27</td> <td>BATTRTN</td> <td>38</td> <td><0.1 V dc</td> <td><10 Ω</td> </tr> <tr> <td>Clock Status B</td> <td>HOLDOVER B</td> <td>3</td> <td>BATTRTN</td> <td>38</td> <td><0.1 V dc</td> <td><0.1 V dc</td> </tr> <tr> <td>Clock Status B</td> <td>LOCK B</td> <td>2</td> <td>BATTRTN</td> <td>38</td> <td><0.1 V dc</td> <td><10 Ω</td> </tr> </tbody> </table> <p>Requirement: The multimeter indicates the readings shown in the Result MIS/C or Result SAI/C column, depending on whether an MIS/C or SAI/C card is installed in the shelf.</p>	Type	Test Point	Pin#	Test Point	Pin#	Result MIS/C	Result SAI/C	Office Alarm	MAJ AUD NO	42	MAJ AUD C	17	<10 Ω	<10 Ω	Office Alarm	MAJ VIS NO	18	MAJ VIS C	44	<10 Ω	<10 Ω	Office Alarm	MIN AUD NO	45	MIN AUD C	20	<10 Ω	<10 Ω	Office Alarm	MIN VIS NO	21	MIN VIS C	47	<10 Ω	<10 Ω	Shelf Status	MAJSI	12	MAJSR	37	<10 Ω	<10 Ω	Shelf Status	MINSI	11	MINSR	36	<10 Ω	<10 Ω	Clock Status A	HOLDOVER A	28	BATTRTN	38	<0.1 V dc	<0.1 V dc	Clock Status A	LOCK A	27	BATTRTN	38	<0.1 V dc	<10 Ω	Clock Status B	HOLDOVER B	3	BATTRTN	38	<0.1 V dc	<0.1 V dc	Clock Status B	LOCK B	2	BATTRTN	38	<0.1 V dc	<10 Ω
Type	Test Point	Pin#	Test Point	Pin#	Result MIS/C	Result SAI/C																																																																								
Office Alarm	MAJ AUD NO	42	MAJ AUD C	17	<10 Ω	<10 Ω																																																																								
Office Alarm	MAJ VIS NO	18	MAJ VIS C	44	<10 Ω	<10 Ω																																																																								
Office Alarm	MIN AUD NO	45	MIN AUD C	20	<10 Ω	<10 Ω																																																																								
Office Alarm	MIN VIS NO	21	MIN VIS C	47	<10 Ω	<10 Ω																																																																								
Shelf Status	MAJSI	12	MAJSR	37	<10 Ω	<10 Ω																																																																								
Shelf Status	MINSI	11	MINSR	36	<10 Ω	<10 Ω																																																																								
Clock Status A	HOLDOVER A	28	BATTRTN	38	<0.1 V dc	<0.1 V dc																																																																								
Clock Status A	LOCK A	27	BATTRTN	38	<0.1 V dc	<10 Ω																																																																								
Clock Status B	HOLDOVER B	3	BATTRTN	38	<0.1 V dc	<0.1 V dc																																																																								
Clock Status B	LOCK B	2	BATTRTN	38	<0.1 V dc	<10 Ω																																																																								
17	<p>Reinsert both clock input cards. Approximately 5 minutes after the FAIL lamps go off, observe the lamps on the MIS/C and both clock cards.</p> <p>Requirement: On both clock cards, the SRC/REF A or B lamp is lit (depending on which clock input [A or B] card came active first. The TNC/C cards are nonrevertive; the TNC-E/C reverts to the highest level available), the LOCKED and ACTIVE lamps are lit, and the HOLD OV lamp is off. The MINOR lamp on the MIS/C is off.</p>																																																																													
18	<p>Connect the multimeter, set to resistance or volts dc as indicated, across the following Office Alarm pins and Shelf Status pins of J5 on the CEP (Figure 3):</p> <table border="1" data-bbox="319 1344 1484 1724"> <thead> <tr> <th>Type</th> <th>Test Point</th> <th>Pin#</th> <th>Test Point</th> <th>Pin#</th> <th>Result MIS/C</th> <th>Result SAI/C</th> </tr> </thead> <tbody> <tr> <td>Office Alarm</td> <td>MAJ AUD NO</td> <td>42</td> <td>MAJ AUD C</td> <td>17</td> <td>>1 MΩ</td> <td>>1 MΩ</td> </tr> <tr> <td>Office Alarm</td> <td>MAJ VIS NO</td> <td>18</td> <td>MAJ VIS C</td> <td>44</td> <td>>1 MΩ</td> <td>>1 MΩ</td> </tr> <tr> <td>Office Alarm</td> <td>MIN AUD NO</td> <td>45</td> <td>MIN AUD C</td> <td>20</td> <td>>1 MΩ</td> <td>>1 MΩ</td> </tr> <tr> <td>Office Alarm</td> <td>MIN VIS NO</td> <td>21</td> <td>MIN VIS C</td> <td>47</td> <td>>1 MΩ</td> <td>>1 MΩ</td> </tr> <tr> <td>Shelf Status</td> <td>MAJSI</td> <td>12</td> <td>MAJSR</td> <td>37</td> <td>>1 MΩ</td> <td>>1 MΩ</td> </tr> <tr> <td>Shelf Status</td> <td>MINSI</td> <td>11</td> <td>MINSR</td> <td>36</td> <td>>1 MΩ</td> <td>>1 MΩ</td> </tr> <tr> <td>Clock Status A</td> <td>HOLDOVER A</td> <td>28</td> <td>BATTRTN</td> <td>38</td> <td>-42 V dc to -56 V dc</td> <td>-42 V dc to -56 V dc</td> </tr> <tr> <td>Clock Status A</td> <td>LOCK A</td> <td>27</td> <td>BATTRTN</td> <td>38</td> <td>-42 V dc to -56 V dc</td> <td>>1 MΩ</td> </tr> <tr> <td>Clock Status B</td> <td>HOLDOVER B</td> <td>3</td> <td>BATTRTN</td> <td>38</td> <td>-42 V dc to -56 V dc</td> <td>-42 V dc to -56 V dc</td> </tr> <tr> <td>Clock Status B</td> <td>LOCK B</td> <td>2</td> <td>BATTRTN</td> <td>38</td> <td>-42 V dc to -56 V dc</td> <td>>1 MΩ</td> </tr> </tbody> </table> <p>Requirement: The multimeter indicates the readings shown in the Result MIS/C or Result SAI/C column, depending on whether an MIS/C or SAI/C card is installed in the shelf.</p>	Type	Test Point	Pin#	Test Point	Pin#	Result MIS/C	Result SAI/C	Office Alarm	MAJ AUD NO	42	MAJ AUD C	17	>1 MΩ	>1 MΩ	Office Alarm	MAJ VIS NO	18	MAJ VIS C	44	>1 MΩ	>1 MΩ	Office Alarm	MIN AUD NO	45	MIN AUD C	20	>1 MΩ	>1 MΩ	Office Alarm	MIN VIS NO	21	MIN VIS C	47	>1 MΩ	>1 MΩ	Shelf Status	MAJSI	12	MAJSR	37	>1 MΩ	>1 MΩ	Shelf Status	MINSI	11	MINSR	36	>1 MΩ	>1 MΩ	Clock Status A	HOLDOVER A	28	BATTRTN	38	-42 V dc to -56 V dc	-42 V dc to -56 V dc	Clock Status A	LOCK A	27	BATTRTN	38	-42 V dc to -56 V dc	>1 MΩ	Clock Status B	HOLDOVER B	3	BATTRTN	38	-42 V dc to -56 V dc	-42 V dc to -56 V dc	Clock Status B	LOCK B	2	BATTRTN	38	-42 V dc to -56 V dc	>1 MΩ
Type	Test Point	Pin#	Test Point	Pin#	Result MIS/C	Result SAI/C																																																																								
Office Alarm	MAJ AUD NO	42	MAJ AUD C	17	>1 MΩ	>1 MΩ																																																																								
Office Alarm	MAJ VIS NO	18	MAJ VIS C	44	>1 MΩ	>1 MΩ																																																																								
Office Alarm	MIN AUD NO	45	MIN AUD C	20	>1 MΩ	>1 MΩ																																																																								
Office Alarm	MIN VIS NO	21	MIN VIS C	47	>1 MΩ	>1 MΩ																																																																								
Shelf Status	MAJSI	12	MAJSR	37	>1 MΩ	>1 MΩ																																																																								
Shelf Status	MINSI	11	MINSR	36	>1 MΩ	>1 MΩ																																																																								
Clock Status A	HOLDOVER A	28	BATTRTN	38	-42 V dc to -56 V dc	-42 V dc to -56 V dc																																																																								
Clock Status A	LOCK A	27	BATTRTN	38	-42 V dc to -56 V dc	>1 MΩ																																																																								
Clock Status B	HOLDOVER B	3	BATTRTN	38	-42 V dc to -56 V dc	-42 V dc to -56 V dc																																																																								
Clock Status B	LOCK B	2	BATTRTN	38	-42 V dc to -56 V dc	>1 MΩ																																																																								

Chart 12. TNC-E/C Card with TNC/C or LNC/C Card Test

STEP	PROCEDURE
19	On the CEP, close the MIN and center pins on the PWR ALM jumper block (JP1) (Figure 3).
20	<p>Remove both clock input cards. Observe the lamps on the MIS/C and both clock cards.</p> <p>Requirement: On the SAI/C or MIS/C card, the MAJOR and MINOR lamps light. On the clock cards, the SRC, LKD, REF, and LOCKED lamps go off, and the HOLDOVER and HOLD OV lamps light red.</p>
21	<p>Reinsert both clock input cards. After the FAIL lamps go off, observe the lamps on the clock input cards, clock cards, and MIS/C after about 5 minutes.</p> <p>Requirement: On the clock input cards, the SRC ACT or SRC ACTIVE lamp is lit. On clock card A, the SRC A and LKD lamps are lit. On clock card B, the REF B and LOCKED lamps are lit. The HOLDOVER (clock card A) and HOLD OV (clock card B) lamps are off. On the MIS/C card, the MINOR lamp is off.</p>
22	If the Holdover mode is to generate a minor alarm for this system, skip this step. Close the MAJ and center pins on the PWR ALM jumper block (JP1) on the CEP (Figure 3).
23	<p>If an SAI/C card is installed in the shelf, skip this step. Use the INIT-REG command for every MRC/C card in the shelf. This initializes all registers on the shelf.</p> <p>Requirement: The response indicates the command was completed successfully.</p>
24	This procedure is completed. Indicate completion of the TNC-E/C with TNC/C or LNC/C Card Test on the Test Sign-off form.

Chart 13. EA10/C and EA10M/C Card Test

STEP	PROCEDURE
	<p>Use this procedure to install EA10/C or EA10M/C cards.</p> <p>Notes:</p> <ol style="list-style-type: none"> 1. Where information is common to the EA10/C and EA10M/C, these cards are collectively referred to as EA/C cards. 2. Depending upon the card option settings, the EA/C may output digital or analog waveforms on any of its outputs. 3. When installing a redundant EA/C card pair, both cards must have the same part number and S/W Rev letter, and both cards must be configured identically to ensure optimum output switching protection. 4. Install one card of a redundant EA/C card pair in an odd-numbered slot, and the other card in the even-numbered slot immediately to the right. 5. When installing a redundant EA/C card pair, install a double-wide output module on the appropriate connectors of the output panel, according to the Installation section of this manual. 6. The timing outputs must be disconnected during this test. 7. Because the EA/C card may be set as part of a redundant pair or as a stand-alone unit, the pulse amplitude may vary slightly when cards are initially installed and coming into service. Depending on the type of test set used (i.e., HP 377722A, Digital Telecom Analyzer), in some cases, the test set may indicate a false loss of signal (LOS), or framing errors, etc. <p>Test Equipment: Dual-trace 100 MHz oscilloscope (refer to Table C for typical oscilloscope settings)</p>
1	<p>Be sure section 8 of SW1 on each EA/C card is set to the OFF position for the purposes of this procedure, and set the other sections of SW1 and SW2 to conform to the requirements for this installation according to the Installation Job Specifications (Figure 15 and Table G).</p>
2	<p>Insert all EA/C cards in the TO slots specified by the local company Installation Job Specifications in all installed master and expansion shelves in the system.</p> <p>Requirements:</p> <ul style="list-style-type: none"> • The installed card performs a lamp test lasting up to 20 seconds. • The FAIL and PORT ALM lamps are off. (If the FAIL lamp lights when a clock or clock input card is active, replace the EA/C card.) • The INP A, INP B, ST A, and ST B lamps light green, indicating the EA/C cards are receiving reference signals from the active clock input cards and clock cards. (If the INP and ST lamps associated with active cards do not light, retest the clock input cards and the clock cards.) • The ACTV lamp lights green, indicating the card is providing outputs. • The option lamps (CCS, CAS, and CRC4) light according to the options selected in Step 1.

Chart 13. EA10/C and EA10M/C Card Test (Contd)

STEP	PROCEDURE
3	<p>Note: The oscilloscope procedure for this step requires that the probes be terminated with the Test Load Impedance given on the waveform figure.</p> <p>Check each output of the cards just installed in the TO slots at the output panel, using a dual-trace 100 MHz oscilloscope. Table C lists the oscilloscope settings.</p> <p>Requirement: The output waveforms must be as shown in Figure 16 and Figure 17.</p>
4	<p>If no redundant output card pairs are installed in the system, go to Step 7. Remove the left card from each redundant output card pair and repeat Step 3 at the output of each redundant output card pair.</p>
5	<p>Replace the left card in each redundant output card pair. Remove the right card from each redundant output card pair and repeat Step 3 at the output of each redundant output card pair.</p>
6	<p>Replace the right card in each redundant output card pair.</p>
7	<p>If section 8 of SW1 is set to conform to this installation, skip this step. Remove the EA/C cards, set section 8 of SW1 to the ON position, and replace the cards.</p>
8	<p>If an SAI/C card is installed in the shelf, skip this step. Use the INIT-REG command for every MRC/C card in the shelf. This initializes all registers on the shelf.</p> <p>Requirement: The response indicates the command was completed successfully.</p>
9	<p>This procedure is completed. Indicate completion of the EA10/C and EA10M/C Card Test on the Test Sign-off form.</p>

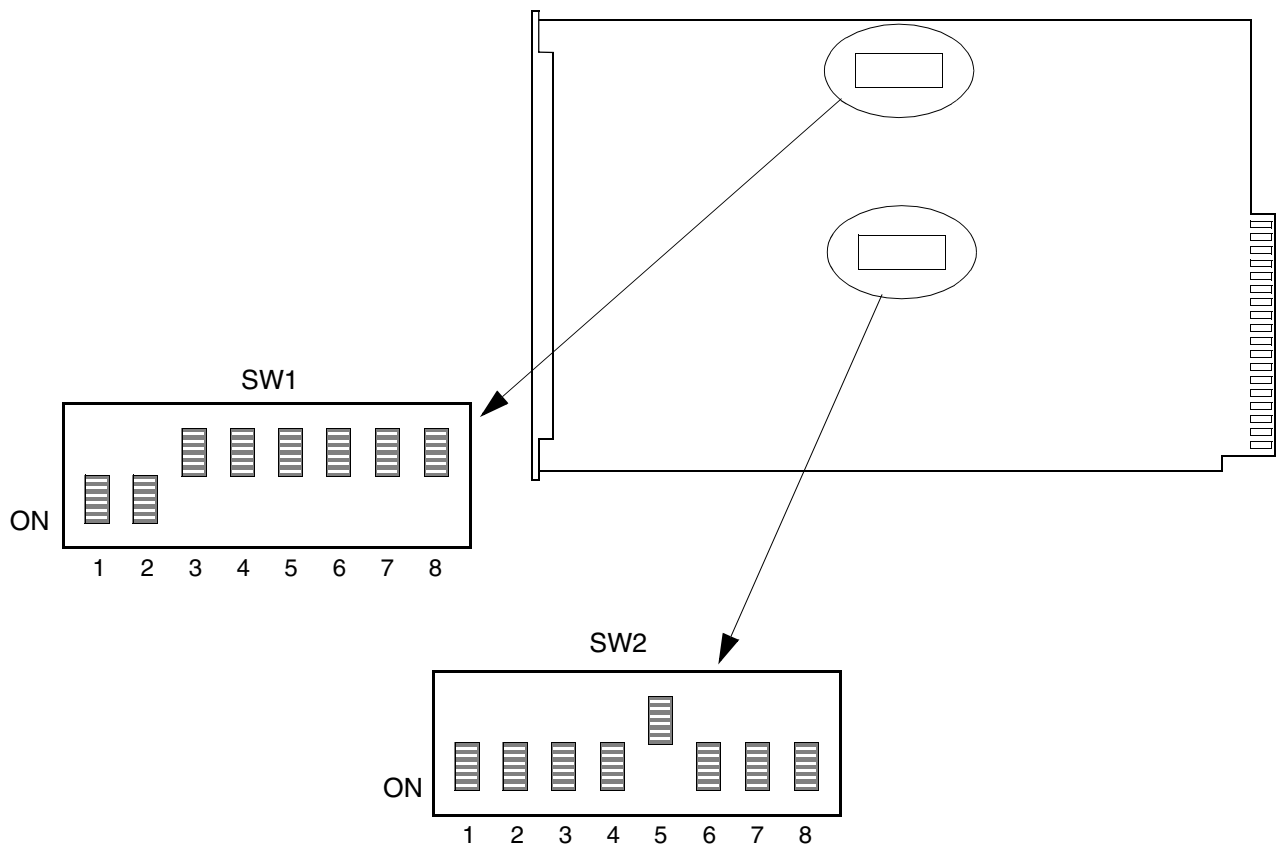

Note: All switches are shown in the factory-set position.

Notes:

1. Refer to Table G for SW1 and SW2 switch settings.
2. Jumpers (not shown) must be left as set by the factory (J2 is closed. J3, J4, and J5 are open.)

Figure 15. EA10/C and EA10M/C Card Switches

Table G. EA10/C and EA10M/C Switch Settings

SECTION	POSITION	MEANING	FACTORY SETTING
SW1 SETTINGS			
Note: If set for E1 output, only one framing format per card is permitted.			
1	OFF	CAS framing	—
	ON	CCS framing	X
2	OFF	CRC-4 Multiframe disabled	—
	ON	CRC-4 Multiframe enabled	X
3	OFF	MINOR alarm initiated upon PORT ALM	X
	ON	MAJOR alarm initiated upon PORT ALM	—
4	OFF	All outputs are squelched upon card failure	X
	ON	Caution: If any port on the card is set for analog output, set SW1 section 4 to the OFF position. AIS is sent on all ports upon card failure	—
5	OFF	Card set for 1+1 outputs (the outputs of both cards of the pair are enabled) (section 5 of SW2 must be set to OFF)	X
	ON	Card set for 1:1 outputs (the outputs of one card of the pair are enabled) (section 5 of SW2 must be set to OFF)	—
6	OFF	For factory use only; must be set to OFF	X
7	OFF	Does not revert back to input signal when it becomes available	X
	ON	Reverts back to input signal when it becomes available Caution: Use of revertive switching may result in phase offsets between cards.	—
8	OFF	Upon power-up, the outputs are enabled, and the card operates using switch settings (if configured properly). Configuration can be changed by TL1 commands.	X
	ON	Upon power-up, the outputs are disabled. If replacing a card, the switch settings on the new card will be overridden by the MIS/C card. Configuration can be changed by TL1 commands.	—
SW2 SETTINGS			
1	OFF	Output ports 1 through 5 designated for Analog signal	—
	ON	Output ports 1 through 5 designated for E1 signal	X
2	OFF	Output ports 6 through 10 designated for Analog signal	—
	ON	Output ports 6 through 10 designated for E1 signal	X
3	ON	Reserved; must be set to ON	X
4	ON	Reserved; must be set to ON	X
5	OFF	Card set for redundant-pair operation (according to section 5 of SW1)	X
	ON	Card set for stand-alone operation	—
6 through 8	ON	Reserved; must be set to ON	X

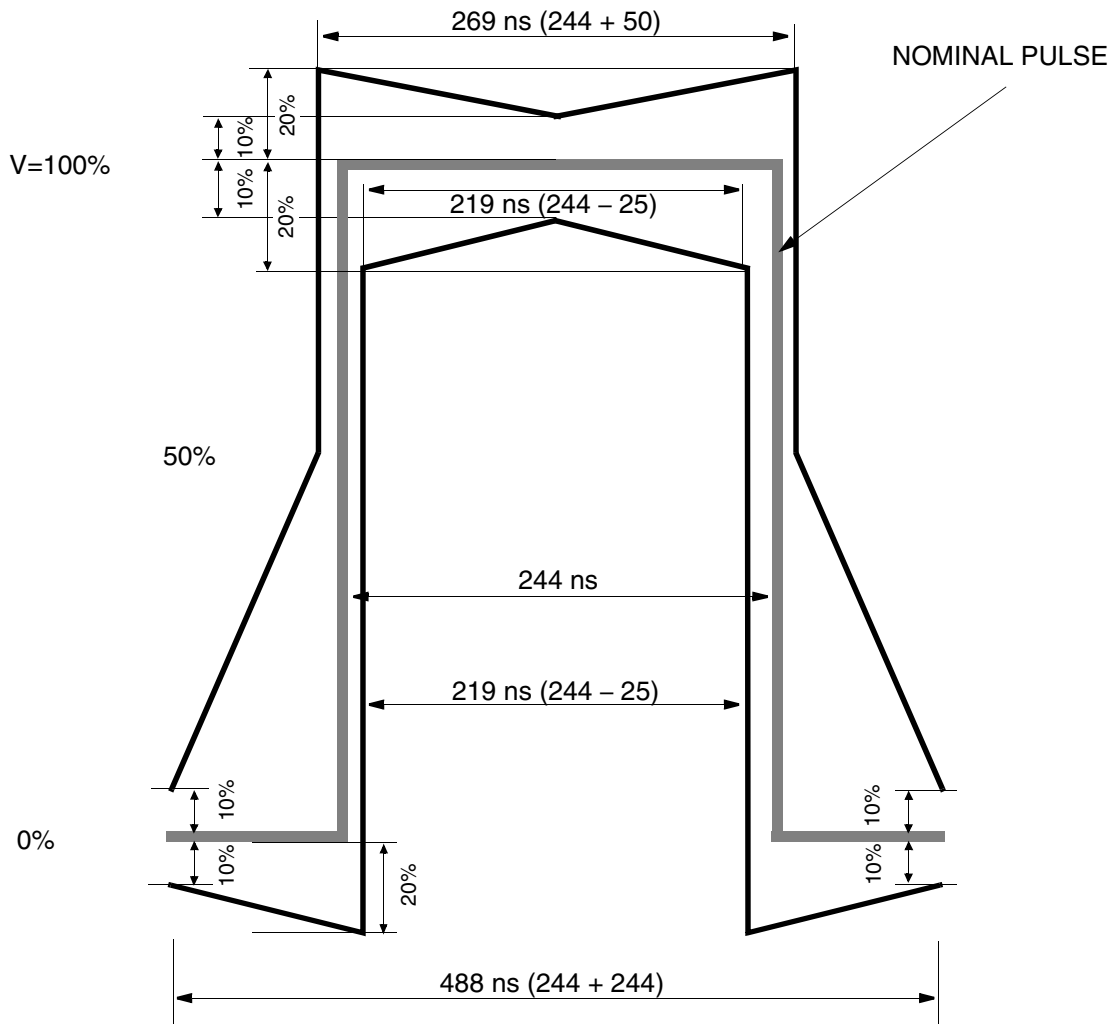

Output Impedance & Levels

Specification	Unbalanced	Balanced
Test Load Impedance	75 Ω resistive	120 Ω resistive
Nominal Peak Voltage of a Mark (Pulse)	2.37 V	3 V
Nominal Peak Voltage of a Space (No Pulse)	0 ±0.237 V	0 ±0.3 V
Nominal Pulse Width	244 ns	244 ns

Figure 16. EA10/C, EA10M/C, TOEA/C, TO-EA/C, and TO-EA5/C Card Digital Output Waveform

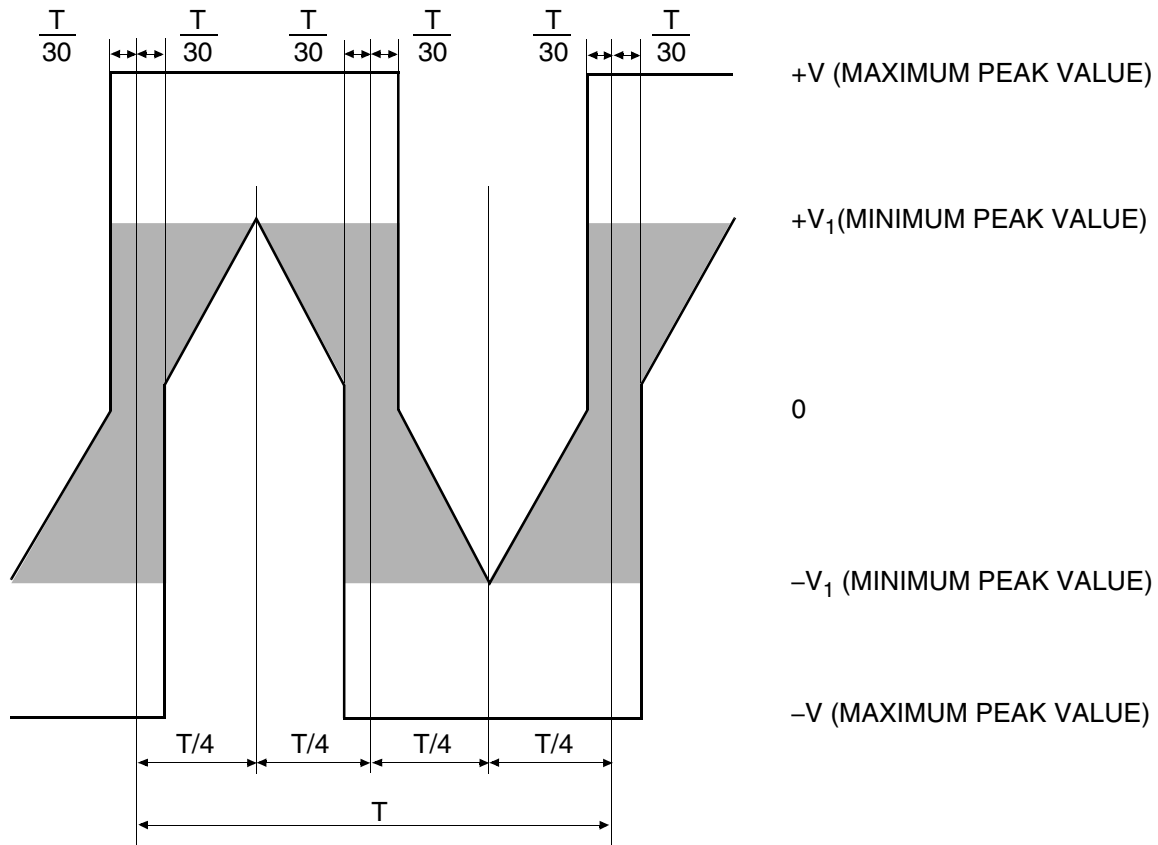

Area in which signal should be monotonic

$T = 488 \text{ ns}$ (approximately) (period of a 2.048 MHz signal)

Output Impedance & Levels

Specification	Unbalanced	Balanced
Test Load Impedance	75 Ω resistive	120 Ω resistive
Maximum Peak Voltage	1.5 V	1.9 V
Minimum Peak Voltage	0.75 V	1.0 V

Figure 17. EA10/C, EA10M/C, TO-EA/C, TO-EA5/C, and TOGA/C Card Analog Output Waveform

Chart 14. TOAA/C and TOLA/C Card Test

STEP	PROCEDURE
	<p>Use this procedure to install a TOAA/C or TOLA/C card.</p> <p>Note: The timing outputs must be disconnected during this test.</p> <p>Test Equipment: Dual-trace 100 MHz oscilloscope (refer to Table C for typical oscilloscope settings)</p>
1	<p>Set the option switches on each TO card to conform to the requirements for this installation according to the Installation Job Specifications (Figure 18 and Figure 19).</p>
2	<p>Insert all TO cards in the TO slots specified by the local company Installation Job Specifications in all installed master and expansion shelves in the system.</p> <p>Requirements:</p> <ul style="list-style-type: none"> • On the TO cards just installed, the FAIL and PORT ALM lamps are off. (If the FAIL lamp lights when a clock or clock input card is active, replace the TO card.) • The ST and INPUT lamps light green (indicating the cards are receiving reference signals). (If the ST and INPUT lamps do not light, retest the clock input cards and the clock cards.) • On each 090-44022-01 or -02 TOAA/C card, a 2048, 1000, 512, or 64 KHZ lamp on the front panel is lit according to the switch settings. • On each TOLA/C card, a 3, 2, 1, or 0 GROUP lamp on the front panel is lit according to the switch settings. <p>Note: 090-44022-05 and 090-44028-10 TOAA/C cards do not have front-panel lamps to indicate frequency.</p>
3	<p>Note: The oscilloscope procedure for this step requires that the probes be terminated with the impedance given on the waveform figure.</p> <p>Check each card output at the output panel with a dual-trace 100 MHz oscilloscope:</p> <ul style="list-style-type: none"> • Table C lists the oscilloscope settings. • Table H lists the TOLA card output frequency groups when using a wire-wrap module. • Table I lists the output signal pins when using a wire-wrap module with an 090-44023-03 TOLA/C card. <p>Requirement: The output waveforms must be as shown in Figure 20 and Figure 21.</p>
4	<p>If an SAI/C card is installed in the shelf, skip this step. Use the INIT-REG command for every MRC/C card in the shelf. This initializes all registers on the shelf.</p> <p>Requirement: The response indicates the command was completed successfully.</p>
5	<p>This procedure is completed. Indicate completion of the TOAA/C and TOLA/C Card Test on the Test Sign-off form.</p>

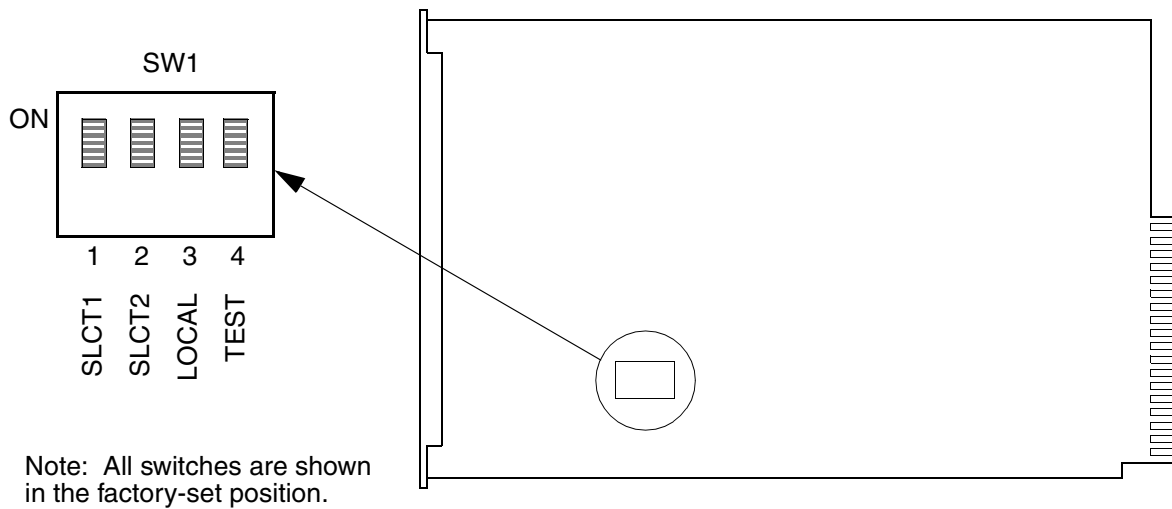

Note: A switch on the front panel of the 090-44028-10 card selects output frequencies of 1.0 MHz, 5.0 MHz, and 10.0 MHz. Do not change any other switch on this card.

SW1 Settings

1	2	3	4	Meaning		Factory Setting
				-01 and -02	-05	
ON	ON	—	—	64 kHz	5MHz	X
ON	OFF	—	—	512 kHz	Not allowed	—
OFF	ON	—	—	1.0 MHz	Not allowed	—
OFF	OFF	—	—	2.048 MHz	Not allowed	—
—	—	ON	—	Not used	Not used	X
—	—	OFF	—	Not used	Not used	—
—	—	—	ON	Normal	Normal	X
—	—	—	OFF	Not allowed	Not allowed	—

Figure 18. TOAA/C Card Switch

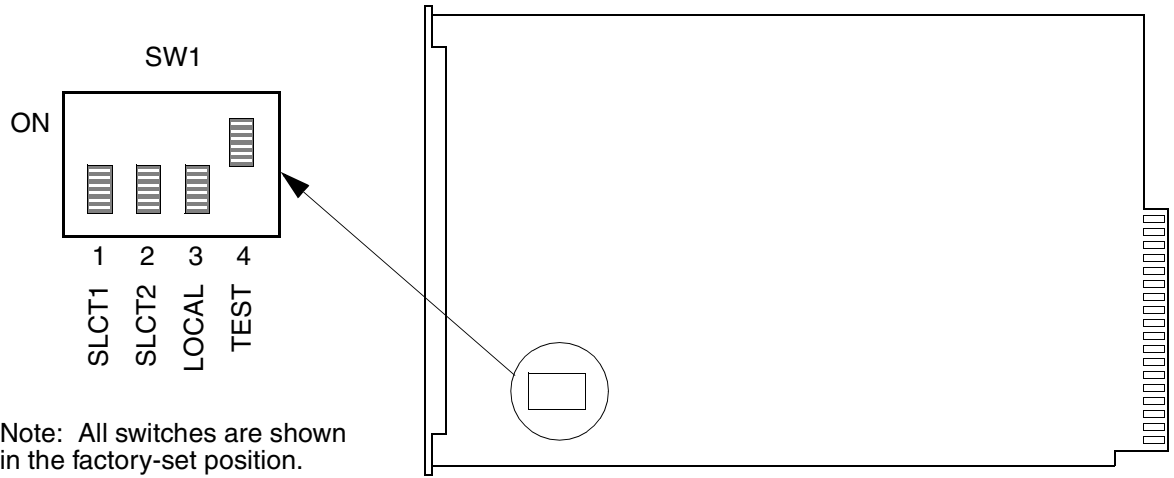

SW1 Settings

1	2	3	4	Meaning	Factory Setting
ON	ON	—	—	Data rate set to Group 0	—
ON	OFF	—	—	Data rate set to Group 1	—
OFF	ON	—	—	Data rate set to Group 2	—
OFF	OFF	—	—	Data rate set to Group 3	X
—	—	ON	—	Not used	—
—	—	OFF	—		X
—	—	—	ON	Normal	X
—	—	—	OFF	Not used	—

Note: Refer to Table H and Table I for the output frequencies of each group.

Figure 19. TOLA/C Card Switch

Table H. TOLA/C Card Output Frequencies (From Wire-wrap Module)

GROUP	OUT 1	OUT 2	OUT 3	OUT 4	OUT 5
TOLA -01/C CARD					
0	1.544 Mb/s	1.544 Mb/s	64 kb/s	8 kb/s	4 kb/s
1	1.544 Mb/s	1.544 Mb/s	2.048 Mb/s	512 kb/s	256 kb/s
2	1.544 Mb/s	1.544 Mb/s	1.536 Mb/s	768 kb/s	384 kb/s
3	1.544 Mb/s	1.544 Mb/s	1.544 Mb/s	1.544 Mb/s	1.544 Mb/s
TOLA -02/C CARD					
0	8 kb/s	8 kb/s	8 kb/s	8 kb/s	8 kb/s
1	1.544 Mb/s	1.544 Mb/s	2.048 Mb/s	512 kb/s	256 kb/s
2	1.544 Mb/s	1.544 Mb/s	1.536 Mb/s	768 kb/s	384 kb/s
3	1.544 Mb/s	1.544 Mb/s	1.544 Mb/s	1.544 Mb/s	1.544 Mb/s
TOLA -03/C CARD					
0	4.8 kb/s	4.8 kb/s	4.8 kb/s	4.8 kb/s	4.8 kb/s
1	9.6 kb/s	9.6 kb/s	9.6 kb/s	9.6 kb/s	9.6 kb/s
2	19.2 kb/s	19.2 kb/s	19.2 kb/s	19.2 kb/s	19.2 kb/s
3	56 kb/s	56 kb/s	56 kb/s	56 kb/s	56 kb/s
TOLA -04/C CARD					
For all groups and all ports, the output is 2.048 Mb/s					
TOLA -05/C CARD					
0	1.544 Mb/s	64 kb/s	128 kb/s	192 kb/s	1.024 Mb/s
1	1.544 Mb/s	64 kb/s	128 kb/s	192 kb/s	1.024 Mb/s
2	1.544 Mb/s	64 kb/s	128 kb/s	192 kb/s	1.024 Mb/s
3	1.544 Mb/s	64 kb/s	128 kb/s	192 kb/s	1.024 Mb/s
Notes:					
1. Outputs for the -01, -02, -04, and -05 are RS-422 or TTL. Outputs for the -03 card are RS-232 only.					
2. When using TTL outputs (each half of the RS-422 signal is used separately) through a 10-output I/O module, the output frequencies of outputs 1 and 2 are the same as listed for OUT 1, outputs 3 and 4 are the same as listed for OUT 2, outputs 5 and 6 are the same as listed for OUT 3, outputs 7 and 8 are the same as listed for OUT 4, and outputs 9 and 10 are the same as listed for OUT 5.					

Table I. Wire-Wrap Output Connections for TOLA-03/C Only

WIRE-WRAP LEADS		TIMING PORT	LEAD
OUTPUT	PIN		
1	T R S	1	CLOCK GND —
2	T R S	—	—
3	T R S	2	CLOCK GND —
4	T R S	—	—
5	T R S	3	CLOCK GND —
6	T R S	—	—

Table I. Wire-Wrap Output Connections for TOLA-03/C Only (Contd)

WIRE-WRAP LEADS		TIMING PORT	LEAD
OUTPUT	PIN		
7	T R S	4	CLOCK GND —
8	T R S	—	—
9	T R S	5	CLOCK GND —
10	T R S	3	TEST GND —

Note: When connecting the TOLA-03/C output ports to NEs for external timing reference, the Tip (T) terminal is the clock lead, and the Ring (R) terminal is the ground lead of the output panel. The Shield (S) terminal is not used. The output ports are on T and R terminal sets 1, 3, 5, 7, and 9.

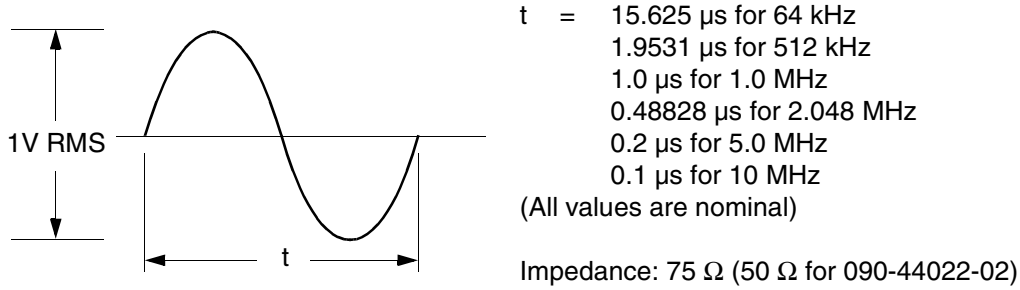
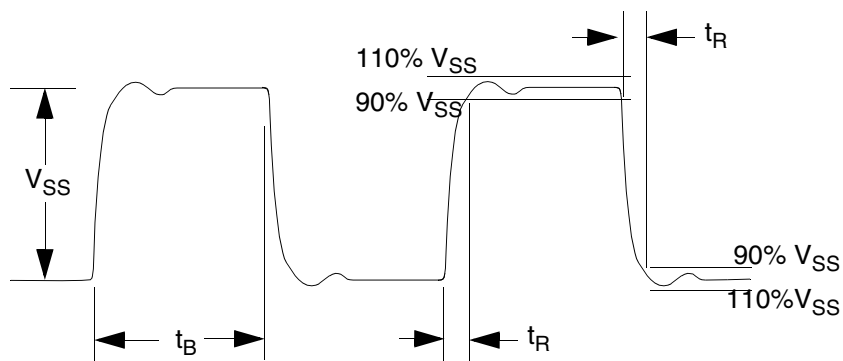

Figure 20. TOAA/C Card Output Waveform



t_B = Bit time duration (8 kb/s to 1.544 Mb/s)
 $t_R = t_B/10$
 V_{SS} = Difference in steady-state voltages:
 2 V to 6 V pp for RS-422 (balanced) into 100Ω
 Greater than 3 V for RS-423 (unbalanced) into 450Ω
 Greater than +3 V from GND and greater than -3 V from GND
 for RS-232 into $3 \text{ k}\Omega$ to $7 \text{ k}\Omega$

Bit Duration			Bit Duration		
Data Rate	t_B	t_R	Data Rate	t_B	t_R
4 kb/s	125 μs	12.5 μs	256 kb/s	1.95 μs	195 μs
4.8 kb/s	104.1 μs	10.41 μs	384 kb/s	1.3 μs	130 ns
8 kb/s	62.5 μs	6.25 μs	512 kb/s	977 ns	97.7 ns
9.6 kb/s	52 μs	5.2 μs	768 kb/s	651 ns	65.1 ns
19.2 kb/s	26 μs	2.6 μs	1.536 Mb/s	326 ns	32.6 ns
56 kb/s	8.9 μs	890 ns	1.544 Mb/s	324 ns	32.4 ns
64 kb/s	7.8 μs	780 ns	2.048 Mb/s	244 ns	24.4 ns

Figure 21. TOLA/C Card Output Waveform

Chart 15. TOCA/C, TOEA/C, and TOTA/C Card Test

STEP	PROCEDURE
	<p>Use this procedure to install TOCA/C, TOEA/C, or TOTA/C cards.</p> <p>Note: The timing outputs must be disconnected during this test.</p> <p>Test Equipment: Dual-trace 100 MHz oscilloscope (refer to Table C for typical oscilloscope settings)</p>
1	Set the option switches on each TO card to conform to the requirements for this installation according to the Installation Job Specifications (Figures 22 through Figure 24).
2	<p>Insert all TO cards in the TO slots specified by the local company Installation Job Specifications in all installed master and expansion shelves in the system.</p> <p>Requirements:</p> <ul style="list-style-type: none"> • On the TO cards just installed, the FAIL and PORT ALM lamps are off. (If the FAIL lamp lights when a clock or clock input card is active, replace the TO card.) • The INPUT and ST lamps light green (indicating the cards are receiving reference signals). (If the INPUT and ST lamps do not light, retest the clock input cards and the clock cards.)
3	<p>Note: The oscilloscope procedure for this step requires that the probes be terminated with the Test Load Impedance given on the waveform figure.</p> <p>Check each output of the cards just installed in the TO slots at the output panel, using a dual-trace 100 MHz oscilloscope. Table C lists the oscilloscope settings.</p> <p>Requirement: The output waveforms must be as shown in Figures 16, 25, and 26.</p>
4	<p>Insert a disabling pin into each of the disabling pin jacks on the front panel of the card, one at a time.</p> <p>Requirement: The output of the port associated with the disabling pin jack is inhibited.</p>
5	Connect all the timing outputs per the Installation section of this manual.
6	<p>If an SAI/C card is installed in the shelf, skip this step. Use the INIT-REG command for every MRC/C card in the shelf. This initializes all registers on the shelf.</p> <p>Requirement: The response indicates the command was completed successfully.</p>
7	This procedure is completed. Indicate completion of the TOCA/C, TOEA/C, or TOTA/C Card Test on the Test Sign-off form.

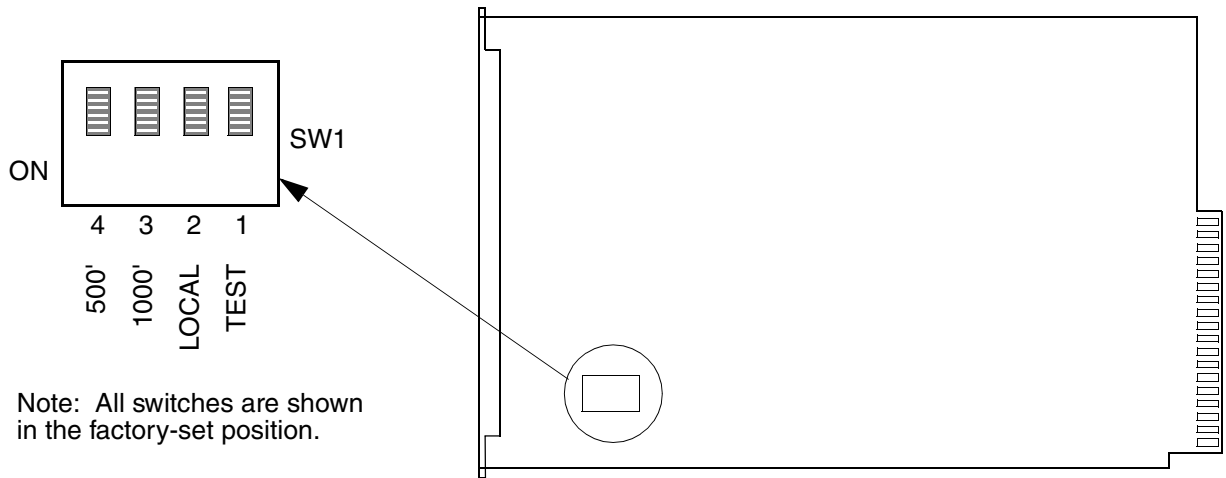

SW1 Settings

4	3	2	1	Meaning	Factory Setting
OFF	OFF	—	—	0 m to 460 m	X
ON	OFF	—	—	461 m to 610 m	—
OFF	ON	—	—	611 m to 760 m	—
ON	ON	—	—	761 m to 910 m	—
—	—	ON	—	PORT ALM lamp lit when disabling pin inserted in jack	—
—	—	OFF	—	PORT ALM lamp NOT lit when disabling pin inserted in jack	X
—	—	—	ON	Not allowed	—
—	—	—	OFF	Normal	X

Figure 22. TOCA/C Card Switch

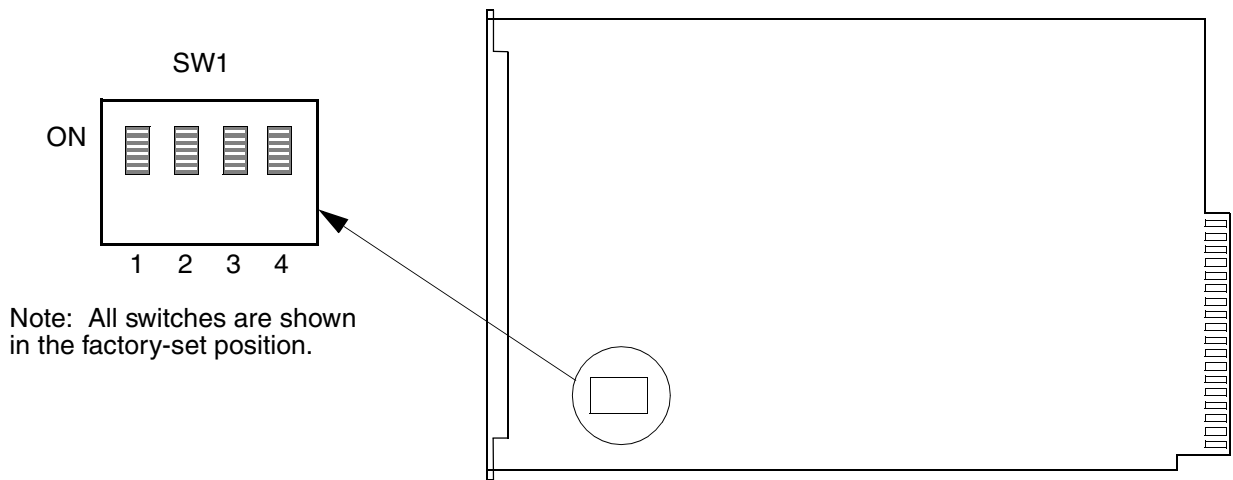

SW1 Settings

SWITCH	POSITION	Meaning	Factory Setting
1	ON	CRC-4 Multiframe enable	X
	OFF	CRC-4 Multiframe disable	—
2	ON	CCS-Common Channel Signaling	X
	OFF	CAS-Channel Associated Signaling	—
3	ON	Not used	X
	OFF	Not used	—
4	ON	Normal	X
	OFF	Not allowed	—

Figure 23. TOEA/C Card Switch

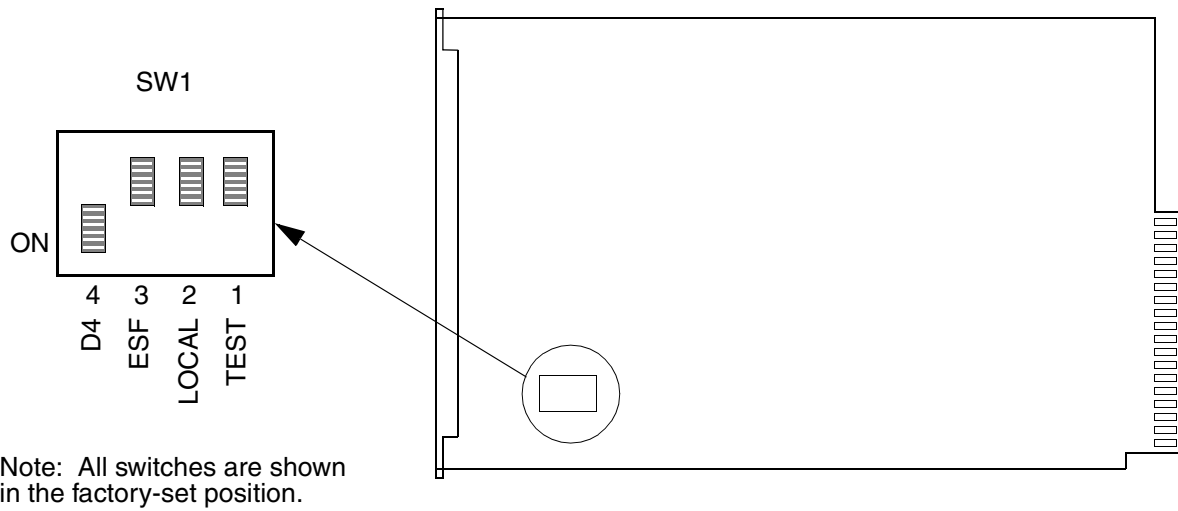

SW1 Settings

4	3	2	1	Meaning	Factory Setting
OFF	OFF	—	—	Not allowed	—
ON	OFF	—	—	D4 framing	X
OFF	ON	—	—	ESF framing	—
ON	ON	—	—	Not allowed	—
—	—	ON	—	PORT ALM lamp lit when disabling pin inserted in jack	—
—	—	OFF	—	PORT ALM lamp NOT lit when disabling pin inserted in jack	X
—	—	—	ON	Not allowed	—
—	—	—	OFF	Normal	X

Figure 24. TOTA/C Card Switch

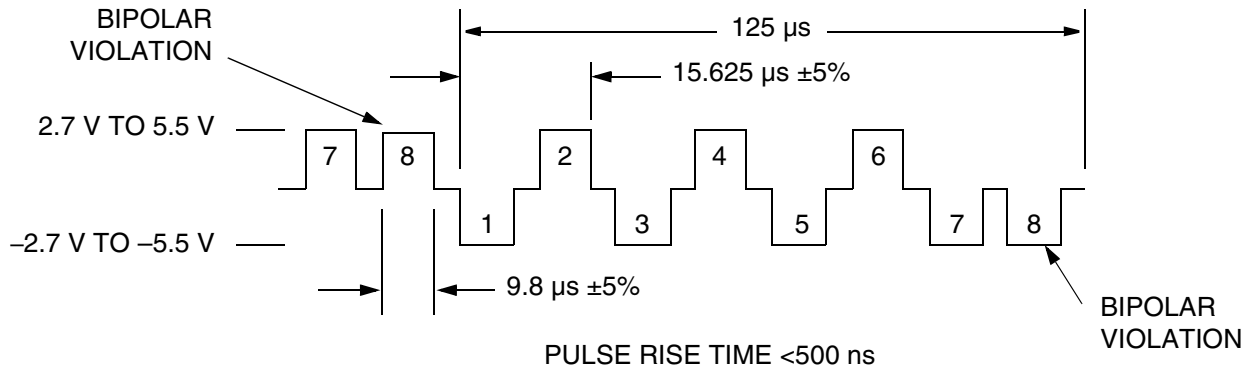

TEST LOAD IMPEDANCE: 133 Ω for 25.3 mils, 0.643 mm (22 AWG) TWISTED PAIR CABLE

Figure 25. TOCA/C Card Output Waveform

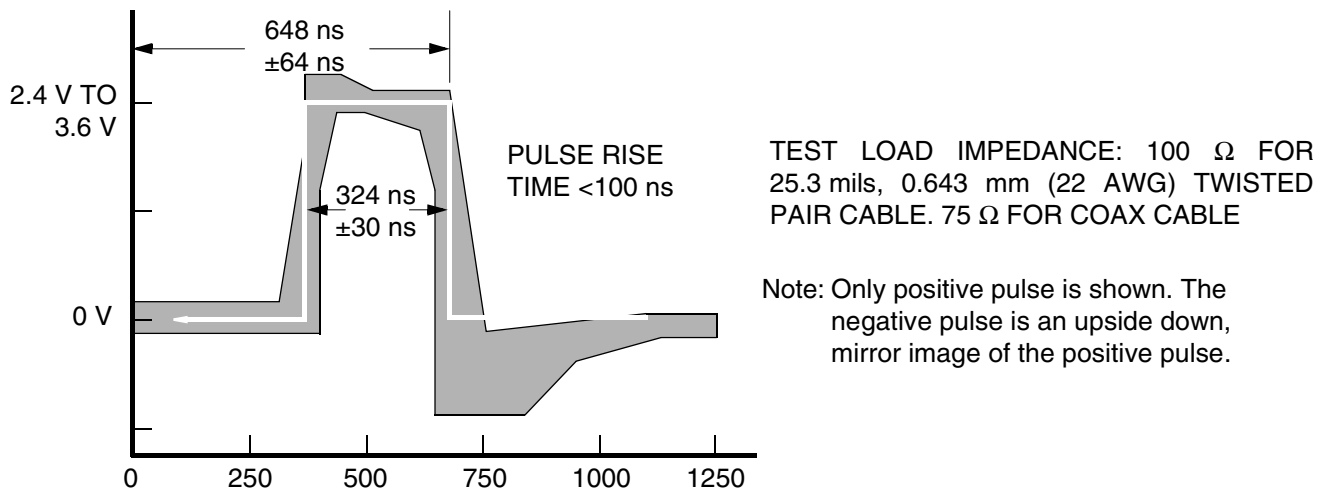

Figure 26. TOTA/C Card Output Waveform

Chart 16. TO-EA/C Card Test

STEP	PROCEDURE
	<p>Use this procedure to install TO-EA/C cards.</p> <p>Notes:</p> <ol style="list-style-type: none"> 1. Depending upon the card option settings, the TO-EA/C may output digital or analog waveforms on any of its outputs. 2. When installing a 1+1 TO-EA/C card pair, both cards must have the same part number and S/W Rev letter, and both cards must be configured identically to ensure optimum output switching protection. 3. When installing a 1+1 TO-EA/C card pair, install a double-wide output module on the appropriate connectors of the output panel. 4. The timing outputs must be disconnected during this test. 5. Because the TO-EA/C card may be set as a 1+1 or stand-alone unit, the pulse amplitude may vary slightly when cards are initially installed and coming into service. Depending on the type of test set used (i.e., HP 377722A, Digital Telecom Analyzer), in some cases, the test set may indicate a false loss of signal (LOS), or framing errors, etc. 6. Insertion of a disabling pin in a single port on a card of a 1+1 pair can cause the signal amplitude at the output module to be reduced from nominal. The result may be marginal with the nominal pulse mask, but well within the specification for signal reception by all office NEs. <p>Test Equipment: Dual-trace 100 MHz oscilloscope (refer to Table C for typical oscilloscope settings)</p>
1	<p>Set SW1, SW2, and SW3 on each TO-EA/C card to conform to the requirements for this installation according to the Installation Job Specifications (Figure 27).</p>
2	<p>Insert all TO-EA/C cards in the TO slots specified by the local company Installation Job Specifications in all installed master and expansion shelves in the system.</p> <p>Requirements:</p> <ul style="list-style-type: none"> • On the TO-EA/C cards just installed, the FAIL and PORT ALM lamps are off. (If the FAIL lamp lights when a clock or clock input card is active, replace the TO card.) • Both INPUT and ST lamps light green (indicating the cards are receiving reference signals). (If both INPUT and ST lamps do not light, retest the clock input cards and the clock cards.)
3	<p>Check each output of the cards just installed in the TO slots at the output panel, using a dual-trace 100 MHz oscilloscope; Table C lists the oscilloscope settings. Figure 16 shows the digital waveform. Figure 17 shows the analog waveform. Table I lists the output signal pins when using a wire-wrap module. The scope probes <i>must</i> be terminated in the Test Load Impedance as stated in the waveform figures.</p> <p>Requirement: The output waveforms must be as shown in the waveform diagrams.</p>

Chart 16. TO-EA/C Card Test (Contd)

STEP	PROCEDURE
4	If no 1+1 output card pairs are installed in the system, skip to Step 7. Remove the left card from each 1+1 output card pair and repeat Step 3 at the output of each 1+1 output card pair.
5	Replace the left card in each 1+1 output card pair. Remove the right card from each 1+1 output card pair and repeat Step 3 at the output of each 1+1 output card pair.
6	Replace the right card in each 1+1 output card pair.
7	Insert a disabling pin into each of the disabling pin jacks on the front panel of the card, one at a time. Requirement: The output of the port associated with the disabling pin jack is inhibited.
8	If an SAI/C card is installed in the shelf, skip this step. Use the INIT-REG command for every MRC/C card in the shelf. This initializes all registers on the shelf. Requirement: The response indicates the command was completed successfully.
9	This procedure is completed. Indicate completion of the TO-EA/C Card Test on the Test Sign-off form.

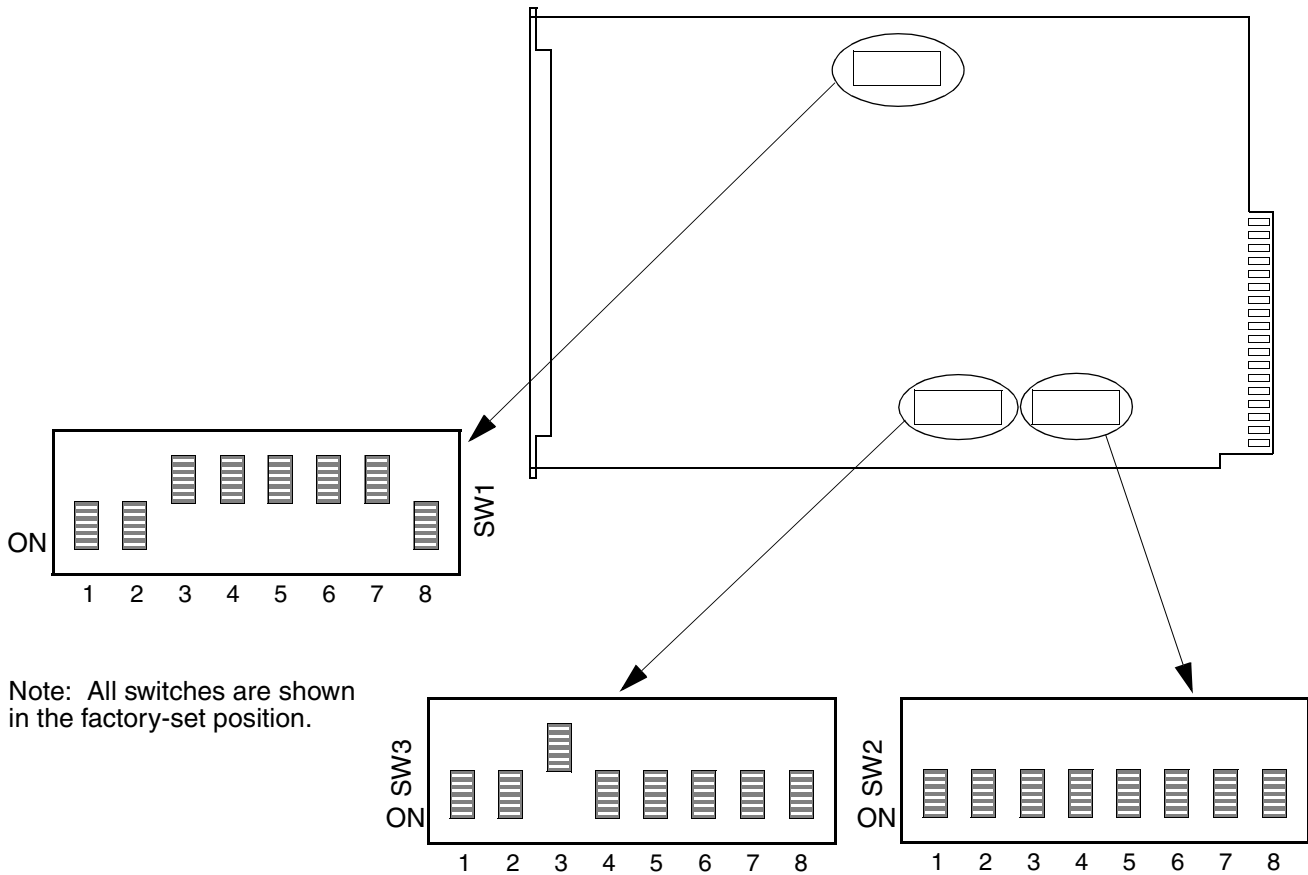

Notes:

1. For TO-EA/C p/n 090-44029-01, refer to Table J for SW1, SW2, and SW3 switch settings.
2. Sections 1 through 8 on SW2 correspond to output ports 1 through 8; sections 1 and 2 on SW3 correspond to output ports 9 and 10; section 3 sets the card operation mode (redundant-pair or stand-alone). Ports can be designated for any combination of E1 and analog outputs.

Figure 27. TO-EA/C Card Switch

Table J. TO-EA/C Card Switch Settings

SECTION	POSITION	MEANING	FACTORY SETTING
SW1 SETTINGS			
Note: If set for E1 output, only one framing format per card is permitted.			
1	OFF	CAS framing	—
	ON	CCS framing	X
2	OFF	CRC-4 Multiframe disabled	—
	ON	CRC-4 Multiframe enabled	X
3	OFF	MINOR alarm initiated upon PORT ALM	X
	ON	MAJOR alarm initiated upon PORT ALM	—
4	OFF	Squelches outputs on a per port basis during MINOR alarm	X
	ON	Sends AIS on a per port basis during MINOR alarm	—
5 and 6	OFF	For factory use only; must be set to OFF	X
7	OFF	Reverts back to input signal when it becomes available	X
	ON	Caution: Use of nonrevertive switching may result in phase offsets between cards. Does not revert back to input signal when it becomes available	—
8	ON	Reserved; must be set to ON	X
Sections 1 through 8 on SW2 correspond to output ports 1 through 8; sections 1 and 2 on SW3 correspond to output ports 9 and 10. Ports can be designated for any combination of E1 and/or analog outputs			
SW2 SETTINGS			
1 through 8	OFF	Output port designated for Analog signal	—
	ON	Output port designated for E1 signal	X
SW3 SETTINGS			
Sections 1 and 2 correspond to output ports 9 and 10.			
1	OFF	Output port 9 designated for Analog signal	—
	ON	Output port 9 designated for E1 signal	X
2	OFF	Output port 10 designated for Analog signal	—
	ON	Output port 10 designated for E1 signal	X
3	OFF	Card set for 1+1 operation	X
	ON	Card set for stand-alone operation	—
4 through 8	ON	Reserved; must be set to ON	X

Chart 17. TO-EA5/C Card Test

STEP	PROCEDURE
	<p>Use this procedure to install TO-EA5/C cards.</p> <p>Notes:</p> <ol style="list-style-type: none"> 1. Depending upon the card option settings, the TO-EA5/C may output digital or analog waveforms on any of its outputs. 2. When installing a redundant TO-EA5/C card pair, both cards must have the same part number and S/W Rev letter, and both cards must be configured identically to ensure optimum output switching protection. 3. Install one card of a redundant pair of TO-EA5/C cards in an odd-numbered slot, and the other card in the even-numbered slot immediately to the right. 4. When installing a redundant TO-EA5/C card pair, install a double-wide output module on the appropriate connectors of the output panel. 5. The timing outputs must be disconnected during this test. 6. Because the TO-EA5/C card may be set as part of a redundant pair or as a stand-alone unit, the pulse amplitude may vary slightly when cards are initially installed and coming into service. Depending on the type of test set used (i.e., HP 377722A, Digital Telecom Analyzer), in some cases, the test set may indicate a false loss of signal (LOS), or framing errors, etc. 7. Inserting a disabling pin in a single port on a card of a redundant pair can cause the amplitude to be reduced from nominal. The result may be marginal with the nominal pulse mask, but well within the specification for signal reception by all office NEs. <p>Test Equipment: Dual-trace 100 MHz oscilloscope (refer to Table C for typical oscilloscope settings)</p>
1	<p>Set section 8 of SW1 on each TO-EA5/C card to the OFF position for the purposes of this procedure, and set the other sections of SW1, SW2, and SW3 on each TO-EA5/C card to conform to the requirements for this installation according to the Installation Job Specifications (Figure 28).</p>
2	<p>Insert all TO-EA5/C cards in the TO slots specified by the local company Installation Job Specifications in all installed master and expansion shelves in the system.</p> <p>Requirements:</p> <ul style="list-style-type: none"> • On the TO-EA5/C cards just installed, the FAIL and PORT ALM lamps are off. (If the FAIL lamp lights when a clock or clock input card is active, replace the TO-EA5/C card.) • Both INPUT and ST lamps light green (indicating the cards are receiving reference signals). (If both INPUT and ST lamps do not light, retest the clock input cards and the clock cards.) • The CCS or CAS lamps are lit according to the options selected in Step 1.

Chart 17. TO-EA5/C Card Test (Contd)

STEP	PROCEDURE
3	<p>Note: The oscilloscope procedure for this step requires that the probes be terminated with the Test Load Impedance given on the waveform figure.</p> <p>Check each output of the cards just installed in the TO slots at the output panel using a dual-trace 100 MHz oscilloscope. Table C lists the oscilloscope settings.</p> <p>Requirement: The output waveforms must be as shown in the waveform diagrams.</p>
4	<p>If no redundant output card pairs are installed in the system, skip to Step 7. Remove the left card from each redundant output card pair and repeat Step 3 at the output of each redundant output card pair.</p>
5	<p>Replace the left card in each redundant output card pair. Remove the right card from each redundant output card pair and repeat Step 3 at the output of each redundant output card pair.</p>
6	<p>Replace the right card in each redundant output card pair.</p>
7	<p>Insert a disabling pin into each of the disabling pin jacks on the front panel of the card, one at a time.</p> <p>Requirement: The output of the port associated with the disabling pin jack is inhibited.</p>
8	<p>If section 8 of SW1 is set to conform to the requirements for this installation, skip this step. Remove the TO-EA5/C cards, set section 8 of SW1 to the ON position, and replace the cards.</p>
9	<p>If an SAI/C card is installed in the shelf, skip this step. Use the INIT-REG command for every MRC/C card in the shelf. This initializes all registers on the shelf.</p> <p>Requirement: The response indicates the command was completed successfully.</p>
10	<p>This procedure is completed. Indicate completion of the TO-EA5/C Card Test on the Test Sign-off form.</p>

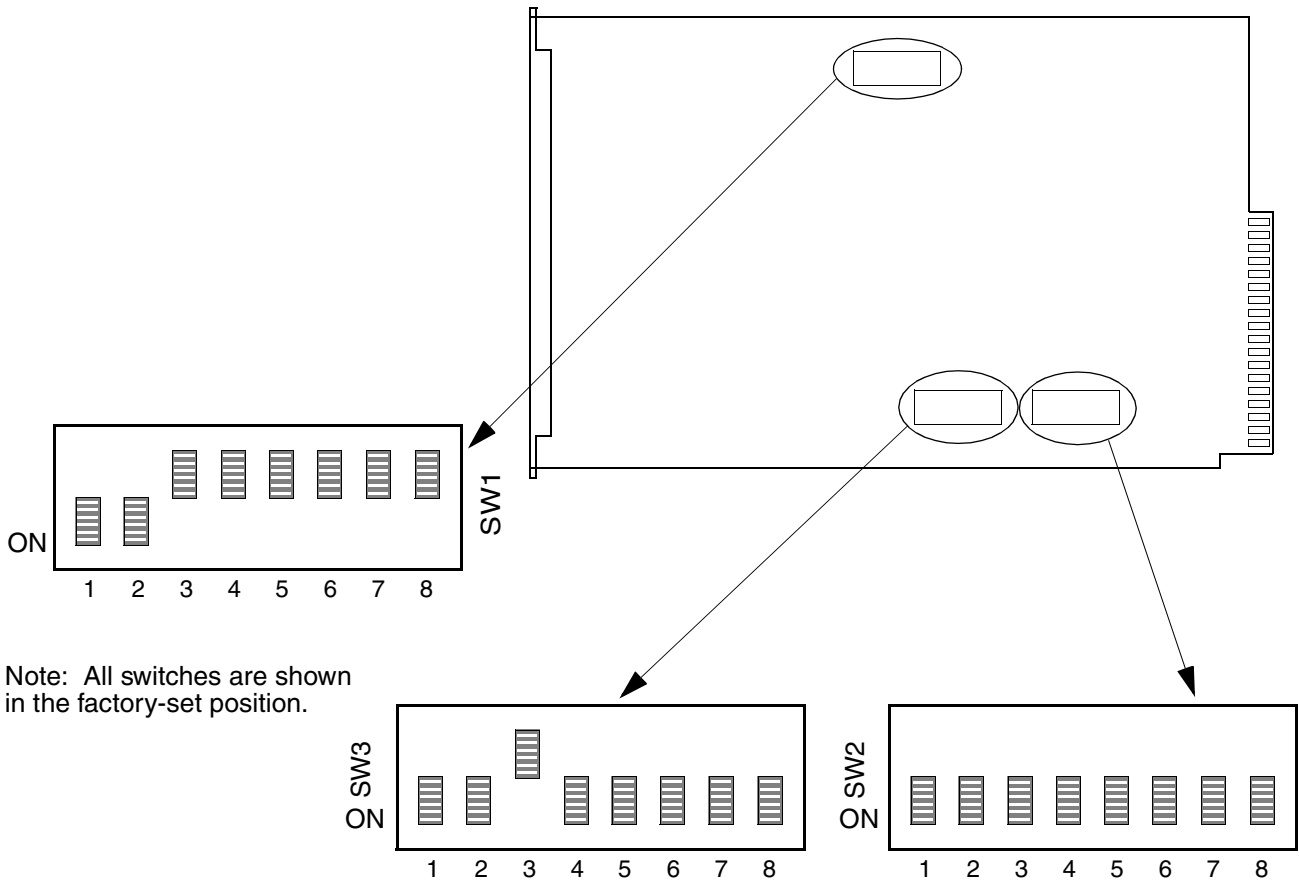

Notes:

1. Refer to Table K for SW1, SW2, and SW3 switch settings.
2. Sections 1 through 8 on SW2 correspond to output ports 1 through 8; sections 1 and 2 on SW3 correspond to output ports 9 and 10; section 3 sets the card operation mode (redundant-pair or stand-alone). Ports can be designated for any combination of E1 and/or analog outputs.

Figure 28. TO-EA5/C Card Switch

Table K. TO-EA5/C Card Switch Settings

SECTION	POSITION	MEANING	FACTORY SETTING
SW1 SETTINGS			
Note: If set for E1 output, only one framing format per card is permitted.			
1	OFF	CAS framing	—
	ON	CCS framing	X
2	OFF	CRC-4 Multiframe disabled	—
	ON	CRC-4 Multiframe enabled	X
3	OFF	MINOR alarm initiated upon PORT ALM	X
	ON	MAJOR alarm initiated upon PORT ALM	—
4	OFF	All outputs are squelched upon card failure	X
	ON	Caution: If any port on the card is set for analog output, set SW1 section 4 to the OFF position. AIS is sent on all ports upon card failure	—
5	OFF	Card set for 1+1 outputs (the outputs of both cards of the pair are enabled)	X
	ON	Card set for 1:1 outputs (the outputs of one card of the pair are enabled)	—
6	OFF	For factory use only; must be set to OFF	X
7	OFF	Caution: Use of nonrevertive switching may result in phase offsets between cards. Does not revert back to input signal when it becomes available	X
	ON	Reverts back to input signal when it becomes available	—
8	OFF	Upon power-up, the outputs are enabled, and the card operates using switch settings (if configured properly). Configuration can be changed by TL1 commands.	X
	ON	Upon power-up, the outputs are disabled. If replacing a card, the switch settings on the new card will be overridden by the MIS/C card. Configuration can be changed by TL1 commands.	—
SW2 SETTINGS			
Sections 1 through 8 on SW2 correspond to output ports 1 through 8			
1 through 8	OFF	Output port designated for Analog signal	—
	ON	Output port designated for E1 signal	X
SW3 SETTINGS			
Sections 1 and 2 correspond to output ports 9 and 10.			
1	OFF	Output port 9 designated for Analog signal	—
	ON	Output port 9 designated for E1 signal	X
2	OFF	Output port 10 designated for Analog signal	—
	ON	Output port 10 designated for E1 signal	X
3	OFF	Card set for redundant-pair operation (1+1 or 1:1 set by SW1 section 5)	X
	ON	Card set for stand-alone operation	—
4 through 8	ON	Reserved; must be set to ON	X

Chart 18. TOGA/C Card Test

STEP	PROCEDURE
	<p>Use this procedure to install TOGA/C cards.</p> <p>Notes:</p> <ol style="list-style-type: none"> 1. The timing outputs must be disconnected during this test. 2. Because the TOGA/C card may be set as a 1+1 or stand-alone unit, the pulse amplitude may vary slightly when cards are initially installed and coming into service. Depending on the type of test set used (i.e., HP 377722A, Digital Telecom Analyzer), in some cases, the test set may indicate a false loss of signal (LOS), or framing errors, etc. 3. Insertion of a disabling pin in a single port on a card of a 1+1 pair can cause the amplitude to be reduced from nominal. The result may be marginal with the nominal pulse mask, but well within the specification for signal reception by all office NEs. <p>Test Equipment: Dual-trace 100 MHz oscilloscope (refer to Table C for typical oscilloscope settings)</p>
1	Set SW1 on each TOGA/C card to conform to the requirements for this installation according to the Installation Job Specifications (Figure 29).
2	<p>Insert all TOGA/C cards in the TO slots specified by the local company Installation Job Specifications in all installed master and expansion shelves in the system.</p> <p>Requirements:</p> <ul style="list-style-type: none"> • On the TOGA/C cards just installed, the FAIL and PORT ALM lamps are off. (If the FAIL lamp lights when a clock or clock input card is active, replace the TO card.) • The INPUT and ST lamps light green (indicating the cards are receiving reference signals). (If the INPUT and ST lamps do not light, retest the clock input cards and the clock cards.)
3	<p>Note: The oscilloscope procedure for this step requires that the probes be terminated with the Test Load Impedance given on the waveform figure.</p> <p>Check each output of the cards just installed in the TO slots at the output panel, using a dual-trace 100 MHz oscilloscope. Table C lists the oscilloscope settings.</p> <p>Requirement: The output waveforms must be as shown in Figure 17.</p>
4	If no 1+1 output card pairs are installed in the system, skip to Step 7. Remove the left card from each 1+1 output card pair and repeat Step 3 at the output of each 1+1 output card pair.

Chart 18. TOGA/C Card Test (Contd)

STEP	PROCEDURE
5	Replace the left card in each 1+1 output card pair. Remove the right card from each 1+1 output card pair and repeat Step 3 at the output of each 1+1 output card pair.
6	Replace the right card in each 1+1 output card pair.
7	<p>Insert a disabling pin into each of the disabling pin jacks on the front panel of the card, one at a time.</p> <p>Requirement: The output of the port associated with the disabling pin jack is inhibited.</p> <p>Note: Inserting a disabling pin in a single port on a card of a 1+1 pair (power-combined redundant card pair) can cause the amplitude to be reduced from nominal. The result may be marginal with the nominal pulse mask, but well within the specification for signal reception by all office NEs.</p>
8	<p>If an SAI/C card is installed in the shelf, skip this step. Use the INIT-REG command for every MRC/C card in the shelf. This initializes all registers on the shelf.</p> <p>Requirement: The response indicates the command was completed successfully.</p>
9	This procedure is completed. Indicate completion of the TOGA/C Card Test on the Test Sign-off form.

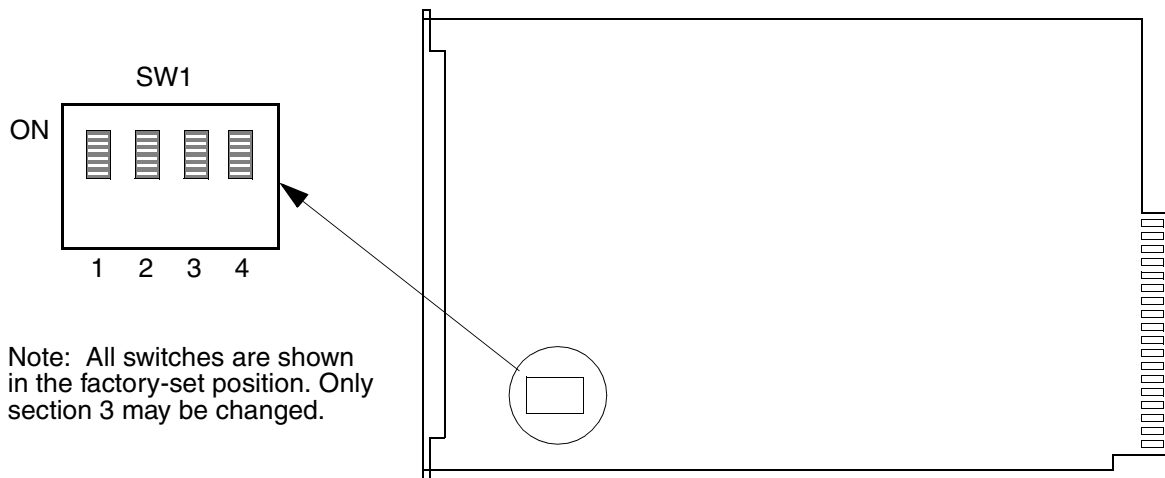

SW1 Settings

SWITCH	POSITION	Meaning	Factory Setting
1	ON	Not used	X
	OFF	Not used	—
2	ON	Not used	X
	OFF	Not used	—
3	ON	When a disabling pin is inserted in jack, a PORT ALM lamp does not light and a switch to the HS card is not made	X
	OFF	When a disabling pin is inserted in jack, PORT ALM lamp lights and a switch to the HS card is made	—
4	ON	Normal	X
	OFF	Not allowed	—

Figure 29. TOGA/C Card Switch

Chart 19. ESCIU/C Card Test

STEP	PROCEDURE
	<p>Use this procedure to install ESCIU/C cards.</p> <p>Test Equipment: An E1 Bit Error Rate Test Set (BERTS). A cable from a network element timing reference is required to synchronize the BERTS to the office timing.</p> <p>Note: If the BERTS connectors are not compatible with the connectors on the ESCIU/C module, connect the BERTS to the Network Element (NE) ends of cables that are connected to the ESCIU/C module.</p>
1	Set up the BERTS transmit signal to match the framing format and line coding of the traffic-carrying system into which the ESCIU/C card will be inserted.
2	<p>Set the option switches on each ESCIU/C card according to the following (refer to Figure 30):</p> <ul style="list-style-type: none"> • Set SW1, sections 1 and 2 to ON, and sections 3 and 4 to OFF. • Set SW2, sections 1 to 6 and 8 to 10 to OFF, and section 7 to ON.
3	<p>Connect a 0 dB (3 V b-p) transmit signal from the BERTS to the EAST A IN connector of the ESCIU/C module with a patch cord. Connect another patch cord from the WEST A OUT connector of the ESCIU/C module to the receive jack on the BERTS. Start the BERTS test and observe the BERTS receiver for 5 minutes.</p> <p>Requirement: On the BERTS receiver, no E1 bit error parameters are exceeded.</p>
4	<p>Move the BERTS transmit patch cord from the EAST A IN connector to the WEST B IN connector. Move the BERTS receive patch cord from the WEST A OUT connector to the EAST B OUT connector. Start the BERTS test and observe the receiver for 5 minutes.</p> <p>Requirement: On the BERTS receiver, no E1 bit error parameters are exceeded.</p>
5	After the test, leave the BERTS patch cords connected.
6	<p>Insert an ESCIU/C card in the first TO slot, and check its lamp status.</p> <p>Requirement: On the ESCIU/C card just installed, the FAIL lamp lights and then goes off, the SYNC and E1B lamps light green, and the E1A lamp lights red. On the MIS/C card, the MAJOR lamp is lit red to indicate that the E1A receive signal is not present.</p> <p>Note: If the FAIL lamp remains lit, replace the card. If the SYNC lamp is lit red, the card is not receiving system reference from the clock input or clock cards, or expansion bus cable; verify the clock input/clock cards are operating correctly in the master shelf. If in an expansion shelf, verify the master to expansion cable is installed correctly.</p>
7	<p>Remove the ESCIU/C card and change SW2, section 7 to OFF, and section 8 to ON. Reinsert the card.</p> <p>Requirement: The MINOR lamp on the MIS/C card is lit (MAJOR lamp goes off on MIS/C card 6 seconds to 10 seconds after the ESCIU/C card is removed).</p>

Chart 19. ESCIU/C Card Test (Contd)

STEP	PROCEDURE
8	<p>Start the BERTS test and observe the receiver for 5 minutes.</p> <p>Requirement: On the BERTS receiver, no E1 bit error parameters are exceeded. Ignore any other indications.</p>
9	<p>Move the BERTS transmit patch cord from the WEST B IN jack to the EAST A IN jack. Move the BERTS receive patch cord from the EAST B OUT jack to the WEST A OUT jack. Restart the BERTS test and observe the receiver for 5 minutes.</p> <p>Requirement: On the BERTS receiver, no E1 bit error parameters are exceeded. Ignore any other indications.</p> <p>Requirement: On the ESCIU/C card, the E1B lamp is lit red, the E1A lamp is lit green, the bit slip lamps (0, 128, and 192) alternately light and then go off, and the SLIP and HI SLIP lamps are lit red.</p>
10	<p>Remove the ESCIU/C card and change SW2, section 8 to OFF, and section 9 to ON. Reinsert the card.</p> <p>Requirement: On the MIS/C card, the MAJOR lamp is lit to indicate E1B receive signal is not present. On the ESCIU/C card, the E1B lamp is lit red.</p>
11	<p>Remove the ESCIU/C card and change SW2, section 9 to OFF, and section 10 to ON. Reinsert the card.</p> <p>Requirement: On the MIS/C card, the MINOR lamp is lit. On the ESCIU/C card, the E1B lamp is lit red (MAJOR lamp goes off on MIS/C card 6 seconds to 10 seconds after the ESCIU/C card is removed).</p>
12	<p>Remove the ESCIU/C card and change SW2, section 10 to OFF, and section 3 to ON. Reinsert the card.</p> <p>Requirement: Initially, the MAJOR and MINOR lamps are off on the MIS/C card. When the SLIP lamp on the ESCIU/C card lights red (may take 5 minutes), the MAJOR lamp lights on the MIS/C card (MINOR lamp goes off on MIS/C card 6 seconds to 10 seconds after the ESCIU/C card is removed).</p>
13	<p>Remove the ESCIU/C card and change SW2, section 3 to OFF, and section 4 to ON. Reinsert the card.</p> <p>Requirement: After 5 minutes, the SLIP lamp on the ESCIU/C card lights red. The MINOR lamp lights on the MIS/C card (if the ESCIU/C card is removed for longer than 6 seconds to 10 seconds, the MAJOR lamp goes off on MIS/C card).</p> <p>Note: If the SLIP lamp on the ESCIU/C card remains off after 5 minutes, check the BERTS for bit slips. If no bit slips have occurred, skip this step (the BERTS oscillator is too stable to show bit slips).</p>

Chart 19. ESCIU/C Card Test (Contd)

STEP	PROCEDURE
14	<p>Remove the ESCIU/C card and change SW2, section 4 to OFF, and section 1 to ON. Reinsert the card.</p> <p>Requirement: After 5 minutes, the SLIP lamp on the ESCIU/C card lights red. On the MIS/C card, the MAJOR and MINOR lamps are off. After another 5 minutes, the HI SLIP lamp on the ESCIU/C card lights red, and the MAJOR lamp on the MIS/C card lights. (If the ESCIU/C card is removed for longer than 6 seconds to 10 seconds, the MINOR lamp goes off on MIS/C card.)</p> <p>Note: If the SLIP lamp on the ESCIU/C card remains off after 5 minutes, check the BERTS for bit slips. If no bit slips have occurred, skip this step (the BERTS oscillator is too stable to show bit slips).</p>
15	<p>Remove the ESCIU/C card and change SW2, section 1 to OFF, and section 2 to ON. Reinsert the card.</p> <p>Requirement: After 5 minutes, the HI SLIP lamp on the ESCIU/C card lights red. On the MIS/C card, the MINOR lamp lights. (If the ESCIU/C card is removed for longer than 6 seconds to 10 seconds, the MAJOR lamp goes off on MIS/C card.)</p> <p>Note: If the SLIP lamp on the ESCIU/C card remains off after 5 minutes, check the BERTS for bit slips. If no bit slips have occurred, skip this step (the BERTS oscillator is too stable to show bit slips).</p>
16	<p>Remove the ESCIU/C card and change SW2, section 2 to OFF. Reinsert the card and wait 10 minutes for the SLIP and HI SLIP lamps to light.</p> <p>Note: If the SLIP lamp on the ESCIU/C card remains off after 5 minutes, check the BERTS for bit slips. If no bit slips have occurred, skip this step (the BERTS oscillator is too stable to show bit slips).</p> <p>Requirement: On the MIS/C card, the MAJOR and MINOR lamps are off.</p>
17	<p>Locate an NE that is being timed from the DCD Shelf. Connect a patch cord from a MON jack on that NE to the external clock reference jack on the BERTS (this synchronizes the BERTS to the office synchronization system.) Restart the BERTS test and observe the receiver for 5 minutes.</p> <p>Requirement: On the BERTS receiver, no E1 bit error parameters are exceeded.</p>
18	<p>At the ESCIU/C card, press the RESET pushbutton on the front panel.</p> <p>Requirement: On the ESCIU/C card, the SLIP and HI SLIP lamps go off. If the 128 or 192 bit slip lamps were lit, they will remain lit.</p>
19	<p>If the 128 or 192 bit slip lamps are off, skip this step. Remove and reinsert the ESCIU/C card.</p> <p>Requirement: On the ESCIU/C card, the SLIP, HI SLIP, and all bit slip lamps are off and remain off for 5 minutes.</p>

Chart 19. ESCIU/C Card Test (Contd)

STEP	PROCEDURE
20	<p>Remove the ESCIU/C card and set switch SW1, section 1 to ON, and section 4 to OFF; and reinsert the card in the shelf. Set the BERTS receive to Auto Signal Detect. Restart the BERTS test and observe the receiver for 5 minutes.</p> <p>Requirement: The BERTS receiver indicates the same signal format as transmitted from the BERTS, with no E1 bit error parameters are exceeded.</p>
21	<p>Remove the BERTS transmit patch cord from the BERTS.</p> <p>Requirement: The BERTS receiver indicates a framed all-ones signal.</p>
22	<p>Reinsert the BERTS transmit patch cord.</p> <p>Requirement: The BERTS receiver indicates a BERTS transmit signal.</p>
23	<p>Send an out-of-frame (OOF) condition from the BERTS.</p> <p>Requirement: The BERTS receiver indicates a framed all-ones signal.</p>
24	<p>Restore framing from BERTS transmitter.</p> <p>Requirement: The BERTS receiver indicates a BERTS transmit signal.</p>
25	<p>Remove the ESCIU/C card and set switch SW1, position 1 to OFF, and position 4 to ON; and reinsert the card in the shelf. Restart the BERTS test and observe the BERTS receiver for 5 minutes.</p> <p>Requirement: The BERTS receiver indicates the same signal format as transmitted from the BERTS, with no E1 bit error parameters exceeded.</p>
26	<p>Remove the transmit patch cord from the BERTS.</p> <p>Requirement: The BERTS receiver indicates a loss-of-signal (LOS).</p>
27	<p>Reinsert the BERTS transmit patch cord.</p> <p>Requirement: The BERTS receiver indicates the BERTS transmit signal.</p>
28	<p>Send OOF condition from the BERTS.</p> <p>Requirement: The BERTS receiver indicates OOF.</p>
29	<p>Reinsert BERTS transmit patch cord.</p> <p>Requirement: The BERTS receiver indicates the BERTS transmit signal.</p>

Chart 19. ESCIU/C Card Test (Contd)

STEP	PROCEDURE
30	<p>On the ESCIU/C card, insert a disabling pin (provided) in the BYPASS jack on the front panel. Restart the BERTS test.</p> <p>Requirement: On the ESCIU/C card, the BYPASS lamp is lit red. On a 5 minute BERTS test, no E1 bit error parameters are exceeded. On the ESCIU/C card, the SLIP, HI SLIP, and bit slip lamps are off.</p>
31	<p>Remove the patch cord from the BERTS external clock reference jack. Restart the BERTS test and observe the receiver for 5 minutes.</p> <p>Requirement: On the BERTS receiver, no E1 bit error parameters are exceeded on the BERTS receiver. On the ESCIU/C card, the SLIP, HI SLIP, and bit slip lamps are off.</p>
32	<p>Remove the disabling pin from the BYPASS jack on the ESCIU/C card.</p> <p>Requirement: On the ESCIU/C card, the BYPASS lamp goes off.</p>
33	<p>Remove the BERTS patch cords from the ESCIU/C access jacks.</p>
34	<p>Remove the ESCIU/C card, and set SW1 and SW2 to conform to the requirements for this installation according to Installation Job Specifications (Figure 30, Table L, and Table M). Reinsert the card in the shelf. The ESCIU/C card does not have option switch settings for LBO.</p> <p>Note: WARN alarm option SW2 (sections 5 and 6) must always be set to OFF. The WARN alarm is associated with the 192-bit slip lamp on the front panel of the ESCIU/C card, and there is no way to reset or clear this alarm until a full frame slip occurs.</p>
35	<p>Repeat Steps 2 through 34 for each ESCIU/C card to be installed in all shelves.</p>
36	<p>If an SAI/C card is installed in the shelf, skip this step. Use the INIT-REG command for every MRC/C card in the shelf. This initializes all registers on the shelf.</p> <p>Requirement: The response indicates the command was completed successfully.</p>
37	<p>This procedure is completed. Indicate completion of the ESCIU/C Card Test on the Test Sign-off form.</p>

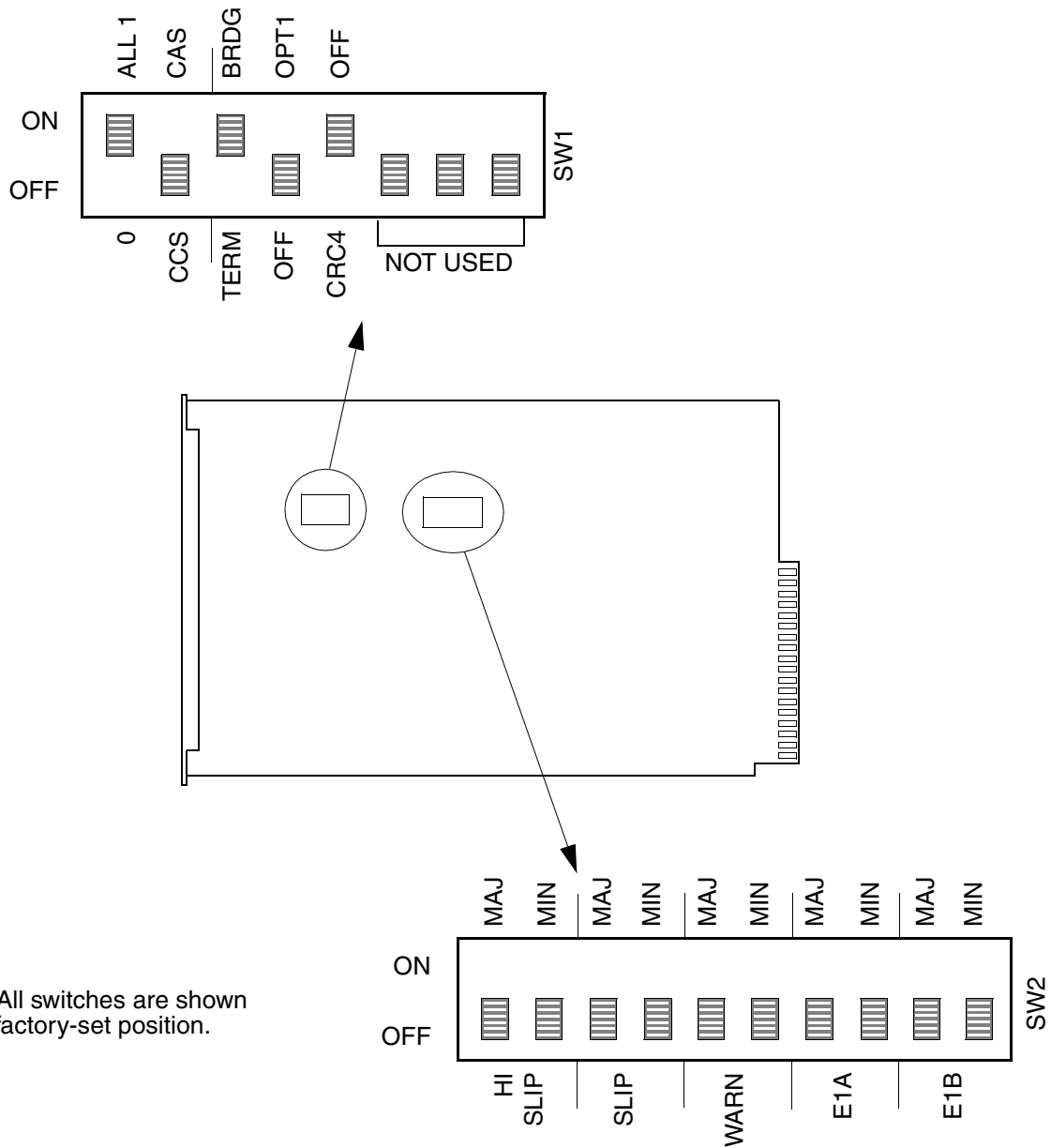

Note: All switches are shown in the factory-set position.

Notes:

1. See Table L and Table M for the ESCIU/C card option switch settings.
2. Factory settings for SW1: 0 / ALL 1, TERM/BRDG, and CRC4/OFF are in the ON (up) position; CCS/CAS, OFF/OPT 1, and the three switches not used are set to the OFF (down) position.
3. Factory settings for SW2: All are set to OFF.
4. On SW2, MAJ and MIN switch positions for each alarm (HI SLIP, SLIP, E1A, and E1B) are mutually exclusive (one ON and the other OFF). Both switches may be set to OFF for a NO ALARM condition.

Figure 30. ESCIU/C Card Switches

Table L. ESCIU/C Card SW1 and SW2 Settings

SECTION	SETTING	RESULT
SWITCH SW1		
0 / ALL 1	See Table M	
CCS/ CAS	ON	CAS Framing
	OFF	CCS Framing (Factory Setting)
TERM / BRDG	ON	Bridged mode (Factory Setting)
	OFF	Terminated mode
OFF OPT1	See Table M	
CRC4/OFF	ON	CRC Disabled (Factory Setting)
	OFF	CRC Enabled
6	Not Used (Factory Setting= OFF)	
7		
8		
SWITCH SW2		
HI SLIP MAJ	ON	Major alarm
HI SLIP MIN	OFF	
HI SLIP MAJ	OFF	Minor alarm
HI SLIP MIN	ON	
HI SLIP MAJ	OFF	No alarm (Factory Setting)
HI SLIP MIN	OFF	
SLIP MAJ	ON	Major alarm
SLIP MIN	OFF	
SLIP MAJ	OFF	Minor alarm
SLIP MIN	ON	

Table L. ESCIU/C Card SW1 and SW2 Settings (Contd)

SECTION	SETTING	RESULT
SWITCH SW2		
SLIP MAJ	OFF	No alarm (Factory Setting)
SLIP MIN	OFF	
WARN MAJ	ON	Major alarm
WARN MIN	OFF	
WARN MAJ	OFF	Minor alarm
WARN MIN	ON	
WARN MAJ	OFF	No alarm (Factory Setting)
WARN MIN	OFF	
E1A MAJ	ON	Major alarm
E1A MIN	OFF	
E1A MAJ	OFF	Minor alarm
E1A MIN	ON	
E1A MAJ	OFF	No alarm (Factory Setting)
E1A MIN	OFF	
E1B MAJ	ON	Major alarm
E1B MIN	OFF	
E1B MAJ	OFF	No alarm
E1B MIN	ON	
E1B MAJ	OFF	No alarm (Factory Setting)
E1B MIN	OFF	

Note: It is recommended the WARN option not be set for alarm activation. If set for alarm activation, the alarm cannot be retired with the reset (RST) button. The WARN alarm is associated with the 192 lamp.

Table M. ESCIU/C Card LOS/OOF Settings

SECTION	SETTING	RESULT		FACTORY SETTING
		INPUT LOS	INPUT OOF	
0 / ALL 1	OFF	LOS output	LOS output	—
OFF / OPT1	OFF			
0 / ALL 1	OFF	LOS output	Received signal output	—
OFF / OPT1	ON			
0 / ALL 1	ON	Framed all-ones output	Framed all-ones output	X
OFF / OPT1	OFF			
0 / ALL 1	ON	Framed all-ones output	Received signal output	—
OFF / OPT1	ON			

Chart 20. PSM/C Card Test

STEP	PROCEDURE
Use this procedure to test PSM/C cards. Prior to testing, this procedure requires that communications have been established with a computer terminal per Chart 1.	
Test Equipment: Optional: E1 and T1 test set, or BERTS	
1	On any PSM/C card, set sections 1 through 4 of switch SW1 to the ON position (Figure 31).
2	Set switch SW3 to accept the framing for the input reference signal (Figure 31).
3	<p>Insert the PSM/C card into the appropriate shelf slot and wait 2 minutes.</p> <p>Note: During the 2 minutes after insertion, the PSM/C card performs a lamp test.</p> <p>Requirement: After the internal DCD timing bus signals have been qualified, the FAIL lamp is off. The REF lamps are lit red for the enabled (but not yet connected) inputs. The TOL lamps are off. The ST and INP lamps are lit green.</p>
4	Repeat Steps 1 through 3 for each remaining PSM/C card to be installed in the system.
5	<p>Temporarily connect one known good timing signal with framing (LNC or better quality, 0 dB signal strength) to PSM/C port 1 at the interface module and wait 2 minutes.</p> <p>Note: Timing signals that are assumed to be good are those from an E1 or T1 test set, such as a BERTS. Another source of timing signals assumed to be good is an E1 or T1 output from a DCD Shelf that is equipped with a reference input, two clock input cards, two clock cards, and an appropriate timing output card, all of which have been tested and are working properly.</p> <p>Note: All four PSM/C card inputs are to be tested. The cables must be disconnected and reconnected during this procedure.</p> <p>Requirement: REF lamp 1 is lit green.</p>
6	Repeat Step 5 with the other the PSM/C input ports.
7	Remove all temporary input timing signals connected in the previous steps.
8	Set the option switches on each PSM/C card to conform to the requirements for this installation according to the Installation Job Specifications (Figure 31 and Tables N through P).
9	Repeat Steps 1 through 8 for each remaining PSM/C card to be installed in the system.
10	Refer to the TL1 Operations or User's Guide manuals that were supplied with the MIS/C card that is installed in the shelf to enter the card into service and perform other required functions.
11	<p>If an SAI/C card is installed in the shelf, skip this step. Use the INIT-REG command for every MRC/C and PSM/C card in the shelf. This initializes all registers on the shelf.</p> <p>Requirement: The response indicates the command was completed successfully.</p>
12	This procedure is completed. Indicate completion of the PSM/C Card Test on the Test Sign-off form.

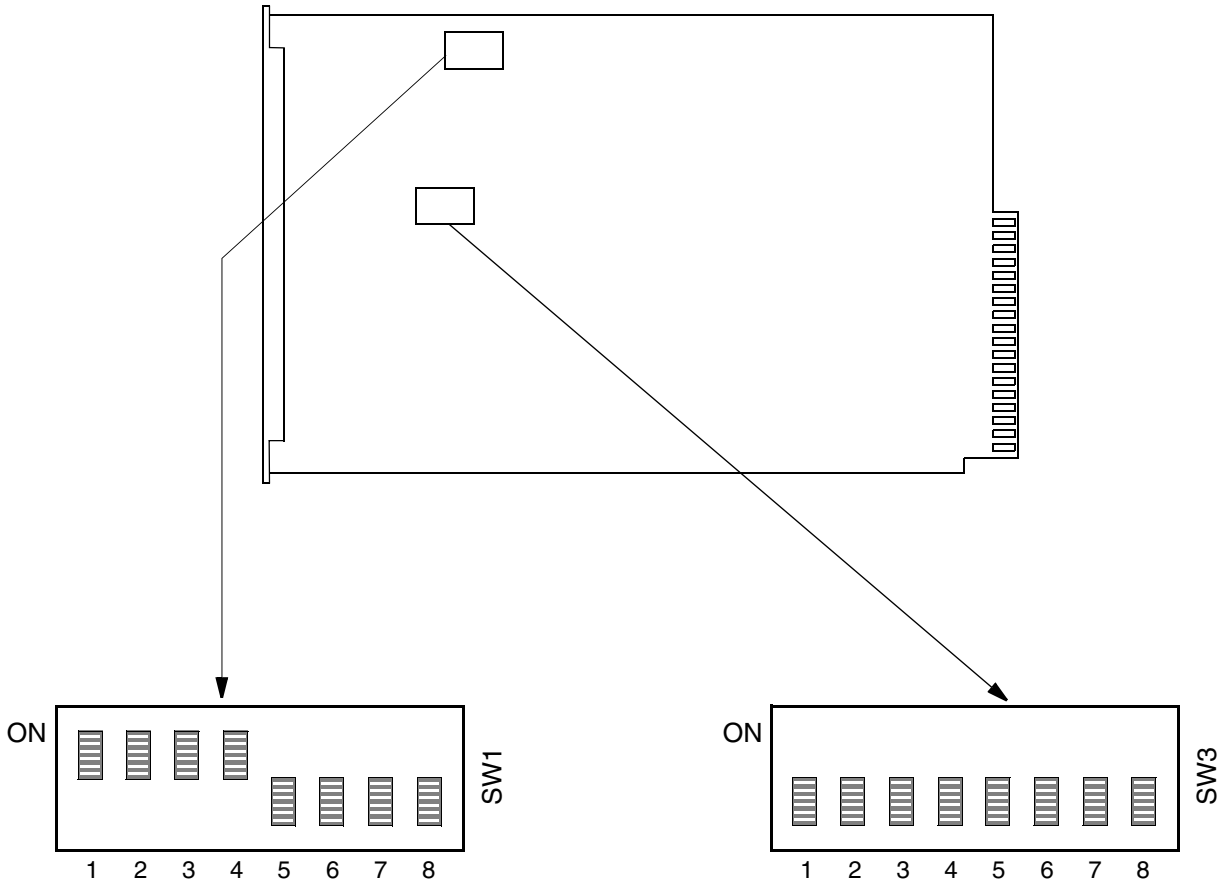

Note: All switches are shown in the factory-set position.

Note: Refer to Table N or Table O for SW1 settings, and Table P or Table Q for SW3 switch settings.

Figure 31. PSM/C Card Switches

Table N. PSM-T/C and PSM-E/C Card Switch SW1 Settings

SECTION	POSITION	MEANING	FACTORY SETTING
1	ON	Input 1 enabled	X
	OFF	Input 1 disabled	—
2	ON	Input 2 enabled	X
	OFF	Input 2 disabled	—
3	ON	Input 3 enabled	X
	OFF	Input 3 disabled	—
4	ON	Input 4 enabled	X
	OFF	Input 4 disabled	—
Note: Sections 5, 6, 7, and 8 are not used and set in the off position.			

Table O. PSM-EA/C Card Switch SW1 Settings

SECTION	POSITION	MEANING	FACTORY SETTING
1	ON	Input 1 enabled	X
	OFF	Input 1 disabled	—
2	ON	Input 2 enabled	X
	OFF	Input 2 disabled	—
3	ON	Input 3 enabled	X
	OFF	Input 3 disabled	—
4	ON	Input 4 enabled	X
	OFF	Input 4 disabled	—
5	ON	Analog signal	—
	OFF	E1 signal	X
6	ON	Analog signal	—
	OFF	E1 signal	X
7	ON	Analog signal	—
	OFF	E1 signal	X
8	ON	Analog signal	—
	OFF	E1 signal	X

Table P. PSM-E/C and PSM-EA/C Card Switch SW3 Settings

SECTION	POSITION	MEANING	FACTORY SETTING
1	ON	CAS multiframing on input 1 enabled	—
	OFF	CCS multiframing on input 1 enabled	X
2	ON	CRC4 multiframing on input 1 enabled	—
	OFF	CRC4 multiframing on input 1 disabled	X
3	ON	CAS multiframing on input 2 enabled	—
	OFF	CCS multiframing on input 2 enabled	X
4	ON	CRC4 multiframing on input 2 enabled	—
	OFF	CRC4 multiframing on input 2 disabled	X
5	ON	CAS multiframing on input 3 enabled	—
	OFF	CCS multiframing on input 3 enabled	X
6	ON	CRC4 multiframing on input 3 enabled	—
	OFF	CRC4 multiframing on input 3 disabled	X
7	ON	CAS multiframing on input 4 enabled	—
	OFF	CCS multiframing on input 4 enabled	X
8	ON	CRC4 multiframing on input 4 enabled	—
	OFF	CRC4 multiframing on input 4 disabled	X

Table Q. PSM-T/C Card Switch SW3 Settings

SECTION/SETTING	MEANING	FACTORY SETTING
1 = ON, 2 = ON	Autoframing on input 1 enabled	—
1 = ON, 2 = OFF	ESF framing on input 1 enabled	—
1 = OFF, 2 = ON	D4 framing on input 1 enabled	—
1 = OFF, 2 = OFF	Autoframing on input 1 enabled	X
3 = ON, 4 = ON	Autoframing on input 2 enabled	—
3 = ON, 4 = OFF	ESF framing on input 2 enabled	—
3 = OFF, 4 = ON	D4 framing on input 2 enabled	—
3 = OFF, 4 = OFF	Autoframing on input 2 enabled	X
5 = ON, 6 = ON	Autoframing on input 3 enabled	—
5 = ON, 6 = OFF	ESF framing on input 3 enabled	—
5 = OFF, 6 = ON	D4 framing on input 3 enabled	—
5 = OFF, 6 = OFF	Autoframing on input 3 enabled	X
7 = ON, 8 = ON	Autoframing on input 4 enabled	—
7 = ON, 8 = OFF	ESF framing on input 4 enabled	—
7 = OFF, 8 = ON	D4 framing on input 4 enabled	—
7 = OFF, 8 = OFF	Autoframing on input 4 enabled	X

Chart 21. MIS/C Card System Management Setup

STEP	PROCEDURE
	<p>Use this procedure to set up the card databases for a shelf that contains a 090-44018-05 or 090-44018-15 MIS/C card as installed and tested in Chart 1 or Chart 2. The standard system uses this information for system management.</p> <p>Note: See the TL1 User's Guide for instructions about commands indicated in this procedure.</p>
1	<p>If SW1 on the MIS card conforms to the requirements for this installation, skip this step. Remove the MIS/C card, set the sections on SW1 to the required positions, and replace the MIS/C card.</p> <p>Requirement: On the MIS/C card (after the lamp test), the FAIL lamp is off, the MAJOR lamp is off, and the MINOR lamp flashes for up to 3 minutes before turning off.</p>
2	<p>If section 4 of SW1 is in the down (off) position, skip this step. Use the ACT-USER command to log on to the MIS/C card.</p> <p>Requirement: The user is logged on.</p>
3	<p>Use the INIT-SYS command with the appropriate <ph> value (see below and the TL1 User's Guide packaged with the appropriate software).</p> <p>If <ph> is 3:</p> <ul style="list-style-type: none"> • Deletes all card information from the database • Retains all security information as previously entered, including the users and passwords • Retains the source ID (SID) as previously entered • Retains all communication parameters as previously entered <p>If <ph> is 9:</p> <ul style="list-style-type: none"> • Deletes all card information from the database • Resets all security information to the factory settings • Resets the source ID (SID) to the factory settings, including only one user named "super" with a password of "sparky" • Resets all communication parameters to factory settings <p>Requirement: After up to 5 minutes, the response includes COMPLD.</p>

Chart 21. MIS/C Card System Management Setup (Contd)

STEP	PROCEDURE
4	<p>Caution: Use the following command to transfer information in the direction indicated. Transferring configuration information to cards that are in service may interrupt service.</p> <p>Use the COPY-MEM command from the shelf to the MIS card to gather configuration information from the standard cards in the DCD-521/C Shelf, and any GTI cards in an associated DCD-LPR/C Shelf.</p> <p>Requirement: The response includes COMPLD.</p>
5	<p>Use the INIT-REG command for every MRC/C and PSM/C card in the shelf. This initializes all registers on the shelf.</p> <p>Requirement: The response includes COMPLD.</p>
6	<p>Refer to the Operations section of the TL1 User's Guide for the steps to put the equipment into service and into the database.</p>
7	<p>If section 4 of SW1 is in the down (off) position, skip this step. Use the CANC-USER command to log off of the MIS/C card.</p> <p>Requirement: The user is logged off.</p>
8	<p>This procedure is completed. Indicate completion of the MIS/C Card System Management Setup on the Test Sign-off form.</p>

Table R. Test Sign-off

CHART #	TEST	COMPLETED
The test and acceptance procedures listed in this section are recommended guidelines. The Test Sign-off form is for customer use only. Use a check mark or initials beside each individual test after test is completed. When all tests have been completed, sign and date at the bottom, and file locally, as per local company practice.		
1	090-44018-05 MIS/C Card Test	
2	090-44018-15 MIS/C Card Test	
3	090-44018-14 MIS/C Card Test	
4	SAI/C Card Test	
5	MRC/C Card Test	
6	ACI/C Card Test	
7	CI-EA/C Card Test	
8	CI/C Card Test	
9	DCIM-EA/C Card Test	
10	TNC-E/C Card Test	
11	TNC/C and LNC/C Card Test	
12	Thermal Insulator Installation	
13	TNC-E/C Card with TNC/C or LNC/C Card Test	
14	EA10/C and EA10M/C Card Test	
15	TOAA/C and TOLA/C Card Test	
16	TOCA/C, TOEA/C, and TOTA/C Card Test	
17	TO-EA/C Card Test	
18	TO-EA5/C Card Test	
19	TOGA/C Card Test	
20	ESCIU/C Card Test	
21	PSM/C Card Test	
22	MIS/C Card System Management Setup	
DCD-521/C Test and Acceptance completed by: _____ Date: _____ Comments:		